

# MS1000 - DATASHEET

## Single axis analog accelerometer

The MS1000 is the best in class capacitive Bulk MEMS accelerometer, specifically designed for inertial applications. Its excellent long term bias and scale factor repeatability, low in-run bias, excellent behavior in vibration (VRE) and low noise allow very accurate and cost effective tactical grade measurements. The internal electronic circuit integrates a signal conditioning with a differential analog  $\pm 2.7V$  output, a Built-in Self-Test, and a temperature sensor for compensation.



### Functional Block Diagram

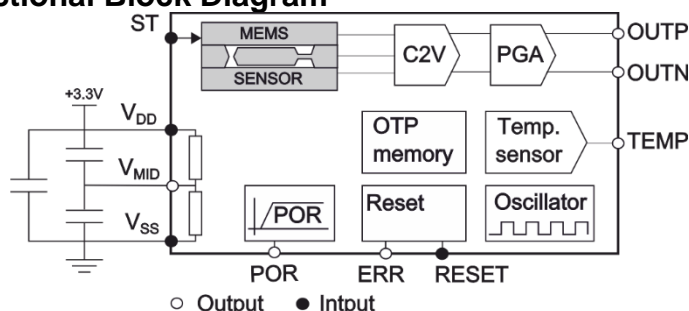

### Key features ( $\pm 10g$ )

- **In run bias stability:** 15  $\mu g$
- **Excellent long term bias repeatability:** 1.2mg
- **Low Noise:** 34  $\mu g/\sqrt{Hz}$
- **Non linearity:**  $\pm 0.3\%$  FS
- **Reliable in harsh environments**
- **LCC20, hermetically sealed package**

Key Parameter, typical values	MS1002*	MS1005*	MS1010*	MS1016	MS1030	MS1100	Unit
Full-Scale acceleration	$\pm 2$	$\pm 5$	$\pm 10$	$\pm 16$	$\pm 30$	$\pm 100$	g
Residual Bias modeling error	0.14	0.35	0.7	1.1	2.1	7.0	mg
Long-term Bias repeatability	0.24	0.6	1.2	1.9	3.6	12.0	mg
In run bias stability	3	7.5	15	24	45	150	$\mu g$
Residual Scale factor modeling error	120	120	120	120	120	120	ppm
Scale Factor Sensitivity	1350	540	270	169	90	27	mV/g
Misalignment	10	10	10	10	10	10	mrad
Noise in band	7	17	34	54	102	340	$\mu g/\sqrt{Hz}$
Non Linearity (IEEE norm)	0.3	0.3	0.3	0.3	0.3	0.3	% FS
Operational temperature	-40 ; +125	-40 ; +125	-40 ; +125	-40 ; +125	-40 ; +125	-40 ; +125	$^{\circ}C$
Operating power consumption	10	10	10	10	10	10	mW
Size	9 x 9	9 x 9	9 x 9	9 x 9	9 x 9	9 x 9	mm <sup>2</sup>

### Featured Applications (non-exhaustive):

#### Aerospace & Defense:

Inertial Measurement Units (IMUs)  
 avionics (fix wings and rotary wings): FCS, autopilot,  
 attitude systems (AHRS, stand by),  
 weapon launch systems – platform stabilization  
 GPS aided guidance & navigation UAV systems  
 short range guidance, robotics

#### Naval & Land:

North finding, antenna, sonar orientation  
 ROV guidance, weapon launch systems,  
 ship navigation and control  
 mobile mapping  
 train positioning (GPS dead reckoning)  
 MWD – drilling guidance

\* The MS1002, MS1005, MS1010 accelerometers are dual-use goods (category 7A101) and as such are subject to export control. Please contact us for additional information.

**MS1002 PARAMETERS**

All values are specified at ambient temperature (20°C) and at 3.3 V supply voltage  $V_{DD}$ , unless otherwise stated. Acceleration values are defined for differential signal (OUTP-OUTN).

Parameter	Comments	Min	Typ.	Max	Unit
<b>Accelerometer</b>					
Full scale		±2			g
Non-Linearity	IEEE Norm , % of full scale		0.3	1.0	%
Frequency response	-3dB	200			Hz
Resonant frequency	Overdamped		1.4		kHz
Vibration rectification error	Mean value over [50Hz , 2kHz]		1'300		$\mu\text{g}/\text{g}^2$
Noise	in band		7		$\mu\text{g}/\sqrt{\text{Hz}}$
Resolution	@ 1Hz		7		$\mu\text{g rms}$
Startup time	Sensor operational, delay once POR triggered		40		$\mu\text{s}$
<b>Bias (K0)</b>					
Nominal	Calibration accuracy	-7		7	mg
Temperature coefficient	Measured over [-40°C , 85°C]		75		$\mu\text{g}/^\circ\text{C}$
Initial residual modeling error	3 <sup>rd</sup> order temperature compensation [-40°C , 85°C]		0.14		mg
Long-term repeatability	See glossary		0.24		mg
In-run bias stability	Based on Allan Variance characterization (@ 10s)		3		$\mu\text{g}$
TurnON - TurnON	See glossary		15		$\mu\text{g}$
<b>Scale factor (K1)</b>					
Nominal	Calibration accuracy	1.33	1.35	1.37	V/g
Temperature coefficient	Measured over [-40°C , 85°C]	20	120	220	ppm/°C
Initial residual modeling error	3 <sup>rd</sup> order temperature compensation [-40°C , 85°C]	-300	120	300	ppm
Long-term repeatability	See glossary		400		ppm
<b>Axis misalignment</b>					
Nominal		-10		10	mrad
<b>Self-test</b>					
Frequency	Square wave output	22	24.4	26.8	Hz
Duty cycle			50		%
Amplitude	Peak to peak		1.0		g
Input threshold voltage	active high	80			% $V_{DD}$
<b>Temperature sensor</b>					
Output voltage @20°C		1.20	1.23	1.26	V
Sensitivity			-4.0		mV/°C
Output current load				10	$\mu\text{A}$
Output capacitive load				10	pF
<b>Reset</b>					
Input threshold voltage	active low			20	% $V_{DD}$
<b>Power requirements</b>					
Supply voltage ( $V_{DD}$ )		3.2	3.3	3.4	V
Supply current ( $I_{DD}$ )			2.3	4	mA

**Accelerometer outputs**

Output voltages	OutP, OutN over full scale	0.14	3.16	V
Differential output	Over full scale	±2.7		V
Resistive load		1000		kΩ
Capacitive load			100	pF

**General**

Reliability assessment	Based on FIDES 2009 Edition A Sept. 2010, available on request.			
------------------------	---	--	--	--

Table 1: MS1002 Specifications

**MS1005 PARAMETERS**

All values are specified at ambient temperature (20°C) and at 3.3 V supply voltage  $V_{DD}$ , unless otherwise stated. Acceleration values are defined for differential signal (OUTP-OUTN).

Parameter	Comments	Min	Typ.	Max	Unit
<b>Accelerometer</b>					
Full scale		±5			g
Non-Linearity	IEEE Norm , % of full scale		0.3	1.0	%
Frequency response	-3dB	200			Hz
Resonant frequency	Overdamped		2.2		kHz
Vibration rectification error	Mean value over [50Hz , 2kHz]		680		$\mu\text{g}/\text{g}^2$
Noise	in band		17		$\mu\text{g}/\sqrt{\text{Hz}}$
Resolution	@ 1Hz		17		$\mu\text{g rms}$
Startup time	Sensor operational, delay once POR triggered		40		$\mu\text{s}$
<b>Bias (K0)</b>					
Nominal	Calibration accuracy	-17		17	mg
Temperature coefficient	Measured over [-40°C , 85°C]		187		$\mu\text{g}/^\circ\text{C}$
Initial residual modeling error	3 <sup>rd</sup> order temperature compensation [-40°C , 85°C]		0.35		mg
Long-term repeatability	See glossary		0.6		mg
In-run bias stability	Based on Allan Variance characterization (@ 10s)		7.5		$\mu\text{g}$
TurnON - TurnON	See glossary		37.5		$\mu\text{g}$
<b>Scale factor (K1)</b>					
Nominal	Calibration accuracy	532	540	548	mV/g
Temperature coefficient	Measured over [-40°C , 85°C]	20	120	220	ppm/ $^\circ\text{C}$
Initial residual modeling error	3 <sup>rd</sup> order temperature compensation [-40°C , 85°C]	-300	120	300	ppm
Long-term repeatability	See glossary		400		ppm
<b>Axis misalignment</b>					
Nominal		-10		10	mrad
<b>Self-test</b>					
Frequency	Square wave output	22	24.4	26.8	Hz
Duty cycle			50		%
Amplitude	Peak to peak		1.0		g
Input threshold voltage	active high	80			% $V_{DD}$
<b>Temperature sensor</b>					
Output voltage @20°C		1.20	1.23	1.26	V
Sensitivity			-4.0		mV/ $^\circ\text{C}$
Output current load				10	$\mu\text{A}$
Output capacitive load				10	pF
<b>Reset</b>					
Input threshold voltage	active low			20	% $V_{DD}$
<b>Power requirements</b>					
Supply voltage ( $V_{DD}$ )		3.2	3.3	3.4	V
Supply current ( $I_{DD}$ )			2.3	4	mA

**Accelerometer outputs**

Output voltages	OutP, OutN over full scale	0.14	3.16	V
Differential output	Over full scale	±2.7		V
Resistive load		1000		kΩ
Capacitive load			100	pF

**General**

Reliability assessment	Based on FIDES 2009 Edition A Sept. 2010, available on request.			
------------------------	---	--	--	--

Table 2: MS1005 Specifications

**MS1010 PARAMETERS**

All values are specified at ambient temperature (20°C) and at 3.3 V supply voltage  $V_{DD}$ , unless otherwise stated. Acceleration values are defined for differential signal (OUTP-OUTN).

Parameter	Comments	Min	Typ.	Max	Unit
<b>Accelerometer</b>					
Full scale		±10			g
Non-Linearity	IEEE Norm , % of full scale		0.3	1.0	%
Frequency response	-3dB	200			Hz
Resonant frequency	Overdamped		3.7		kHz
Vibration rectification error	Mean value over [50Hz , 2kHz]		290		$\mu\text{g}/\text{g}^2$
Noise	in band		34		$\mu\text{g}/\sqrt{\text{Hz}}$
Resolution	@ 1Hz		34		$\mu\text{g rms}$
Startup time	Sensor operational, delay once POR triggered		40		$\mu\text{s}$
<b>Bias (K0)</b>					
Nominal	Calibration accuracy	-34		34	mg
Temperature coefficient	Measured over [-40°C , 85°C]		375		$\mu\text{g}/^\circ\text{C}$
Initial residual modeling error	3 <sup>rd</sup> order temperature compensation [-40°C , 85°C]		0.7		mg
Long-term repeatability	See glossary		1.2		mg
In-run bias stability	Based on Allan Variance characterization (@ 10s)		15		$\mu\text{g}$
TurnON - TurnON	See glossary		75		$\mu\text{g}$
<b>Scale factor (K1)</b>					
Nominal	Calibration accuracy	266	270	274	mV/g
Temperature coefficient	Measured over [-40°C , 85°C]	20	120	220	ppm/ $^\circ\text{C}$
Initial residual modeling error	3 <sup>rd</sup> order temperature compensation [-40°C , 85°C]	-300	120	300	ppm
Long-term repeatability	See glossary		400		ppm
<b>Axis misalignment</b>					
Nominal		-10		10	mrad
<b>Self-test</b>					
Frequency	Square wave output	22	24.4	26.8	Hz
Duty cycle			50		%
Amplitude	Peak to peak		1.0		g
Input threshold voltage	active high	80			% $V_{DD}$
<b>Temperature sensor</b>					
Output voltage @20°C		1.20	1.23	1.26	V
Sensitivity			-4.0		mV/ $^\circ\text{C}$
Output current load				10	$\mu\text{A}$
Output capacitive load				10	pF
<b>Reset</b>					
Input threshold voltage	active low			20	% $V_{DD}$
<b>Power requirements</b>					
Supply voltage ( $V_{DD}$ )		3.2	3.3	3.4	V
Supply current ( $I_{DD}$ )			2.3	4	mA

**Accelerometer outputs**

Output voltages	OutP, OutN over full scale	0.14	3.16	V
Differential output	Over full scale	±2.7		V
Resistive load		1000		kΩ
Capacitive load			100	pF

**General**

Reliability assessment	Based on FIDES 2009 Edition A Sept. 2010, available on request.			
------------------------	---	--	--	--

Table 3: MS1010 Specifications

**MS1016 PARAMETERS**

All values are specified at ambient temperature (20°C) and at 3.3 V supply voltage  $V_{DD}$ , unless otherwise stated. Acceleration values are defined for differential signal (OUTP-OUTN).

Parameter	Comments	Min	Typ.	Max	Unit
<b>Accelerometer</b>					
Full scale		±16			g
Non-Linearity	IEEE Norm , % of full scale		0.3	1.0	%
Frequency response	-3dB	200			Hz
Resonant frequency	Overdamped		8		kHz
Vibration rectification error	Mean value over [50Hz , 2kHz]		230		$\mu\text{g}/\text{g}^2$
Noise	in band		54		$\mu\text{g}/\sqrt{\text{Hz}}$
Resolution	@ 1Hz		54		$\mu\text{g rms}$
Startup time	Sensor operational, delay once POR triggered		40		$\mu\text{s}$
<b>Bias (K0)</b>					
Nominal	Calibration accuracy	-54		54	mg
Temperature coefficient	Measured over [-40°C , 85°C]		600		$\mu\text{g}/^\circ\text{C}$
Initial residual modeling error	3 <sup>rd</sup> order temperature compensation [-40°C , 85°C]		1.1		mg
Long-term repeatability	See glossary		1.9		mg
In-run bias stability	Based on Allan Variance characterization (@ 10s)		24		$\mu\text{g}$
TurnON - TurnON	See glossary		120		$\mu\text{g}$
<b>Scale factor (K1)</b>					
Nominal	Calibration accuracy	166	169	172	mV/g
Temperature coefficient	Measured over [-40°C , 85°C]	20	120	220	ppm/ $^\circ\text{C}$
Initial residual modeling error	3 <sup>rd</sup> order temperature compensation [-40°C , 85°C]	-300	120	300	ppm
Long-term repeatability	See glossary		400		ppm
<b>Axis misalignment</b>					
Nominal		-10		10	mrad
<b>Self-test</b>					
Frequency	Square wave output	22	24.4	26.8	Hz
Duty cycle			50		%
Amplitude	Peak to peak		1.0		g
Input threshold voltage	active high	80			% $V_{DD}$
<b>Temperature sensor</b>					
Output voltage @20°C		1.20	1.23	1.26	V
Sensitivity			-4.0		mV/ $^\circ\text{C}$
Output current load				10	$\mu\text{A}$
Output capacitive load				10	pF
<b>Reset</b>					
Input threshold voltage	active low			20	% $V_{DD}$
<b>Power requirements</b>					
Supply voltage ( $V_{DD}$ )		3.2	3.3	3.4	V
Supply current ( $I_{DD}$ )			2.3	4	mA



**Accelerometer outputs**

Output voltages	OutP, OutN over full scale	0.14	3.16	V
Differential output	Over full scale	±2.7		V
Resistive load		1000		kΩ
Capacitive load			100	pF

**General**

Reliability assessment	Based on FIDES 2009 Edition A Sept. 2010, available on request.			
------------------------	---	--	--	--

Table 4: MS1016 Specifications

**MS1030 PARAMETERS**

All values are specified at ambient temperature (20°C) and at 3.3 V supply voltage  $V_{DD}$ , unless otherwise stated. Acceleration values are defined for differential signal (OUTP-OUTN).

Parameter	Comments	Min	Typ.	Max	Unit
<b>Accelerometer</b>					
Full scale		±30			g
Non-Linearity	IEEE Norm , % of full scale		0.3	1.0	%
Frequency response	-3dB	200			Hz
Resonant frequency	Overdamped		>8		kHz
Vibration rectification error	Mean value over [50Hz , 2kHz]		170		$\mu\text{g}/\text{g}^2$
Noise	in band		102		$\mu\text{g}/\sqrt{\text{Hz}}$
Resolution	@ 1Hz		102		$\mu\text{g rms}$
Startup time	Sensor operational, delay once POR triggered		40		$\mu\text{s}$
<b>Bias (K0)</b>					
Nominal	Calibration accuracy	-100		100	mg
Temperature coefficient	Measured over [-40°C , 85°C]		1.125		$\text{mg}/^\circ\text{C}$
Initial residual modeling error	3 <sup>rd</sup> order temperature compensation [-40°C , 85°C]		2.1		mg
Long-term repeatability	See glossary		3.6		mg
In-run bias stability	Based on Allan Variance characterization (@ 10s)		45		$\mu\text{g}$
TurnON - TurnON	See glossary		225		$\mu\text{g}$
<b>Scale factor (K1)</b>					
Nominal	Calibration accuracy	88.5	90	91.5	mV/g
Temperature coefficient	Measured over [-40°C , 85°C]	20	120	220	$\text{ppm}/^\circ\text{C}$
Initial residual modeling error	3 <sup>rd</sup> order temperature compensation [-40°C , 85°C]	-300	120	300	ppm
Long-term repeatability	See glossary		400		ppm
<b>Axis misalignment</b>					
Nominal		-10		10	mrad
<b>Self-test</b>					
Frequency	Square wave output	22	24.4	26.8	Hz
Duty cycle			50		%
Amplitude	Peak to peak		1.0		g
Input threshold voltage	active high	80			% $V_{DD}$
<b>Temperature sensor</b>					
Output voltage @20°C		1.20	1.23	1.26	V
Sensitivity			-4.0		$\text{mV}/^\circ\text{C}$
Output current load				10	$\mu\text{A}$
Output capacitive load				10	pF
<b>Reset</b>					
Input threshold voltage	active low			20	% $V_{DD}$
<b>Power requirements</b>					
Supply voltage ( $V_{DD}$ )		3.2	3.3	3.4	V
Supply current ( $I_{DD}$ )			2.3	4	mA

**Accelerometer outputs**

Output voltages	OutP, OutN over full scale	0.14	3.16	V
Differential output	Over full scale	±2.7		V
Resistive load		1000		kΩ
Capacitive load			100	pF

**General**

Reliability assessment	Based on FIDES 2009 Edition A Sept. 2010, available on request.			
------------------------	---	--	--	--

Table 5: MS1030 Specifications

**MS1100 PARAMETERS**

All values are specified at ambient temperature (20°C) and at 3.3 V supply voltage  $V_{DD}$ , unless otherwise stated. Acceleration values are defined for differential signal (OUTP-OUTN).

Parameter	Comments	Min	Typ.	Max	Unit
<b>Accelerometer</b>					
Full scale		±100			g
Non-Linearity	IEEE Norm , % of full scale		0.3	1.0	%
Frequency response	-3dB	200			Hz
Resonant frequency	Overdamped		>8		kHz
Vibration rectification error	Mean value over [50Hz , 2kHz]		31		$\mu\text{g}/\text{g}^2$
Noise	in band		340		$\mu\text{g}/\sqrt{\text{Hz}}$
Resolution	@ 1Hz		340		$\mu\text{g rms}$
Startup time	Sensor operational, delay once POR triggered		40		$\mu\text{s}$
<b>Bias (K0)</b>					
Nominal	Calibration accuracy	-333		333	mg
Temperature coefficient	Measured over [-40°C , 85°C]		3.7		$\text{mg}/^\circ\text{C}$
Initial residual modeling error	3 <sup>rd</sup> order temperature compensation [-40°C , 85°C]		7		mg
Long-term repeatability	See glossary		12		mg
In-run bias stability	Based on Allan Variance characterization (@ 10s)		150		$\mu\text{g}$
TurnON - TurnON	See glossary		750		$\mu\text{g}$
<b>Scale factor (K1)</b>					
Nominal	Calibration accuracy	26	27	28	mV/g
Temperature coefficient	Measured over [-40°C , 85°C]	20	120	220	ppm/ $^\circ\text{C}$
Initial residual modeling error	3 <sup>rd</sup> order temperature compensation [-40°C , 85°C]	-300	120	300	ppm
Long-term repeatability	See glossary		400		ppm
<b>Axis misalignment</b>					
Nominal		-10		10	mrad
<b>Self-test</b>					
Frequency	Square wave output	22	24.4	26.8	Hz
Duty cycle			50		%
Amplitude	Peak to peak		1.0		g
Input threshold voltage	active high	80			% $V_{DD}$
<b>Temperature sensor</b>					
Output voltage @20°C		1.20	1.23	1.26	V
Sensitivity			-4.0		$\text{mV}/^\circ\text{C}$
Output current load				10	$\mu\text{A}$
Output capacitive load				10	pF
<b>Reset</b>					
Input threshold voltage	active low			20	% $V_{DD}$
<b>Power requirements</b>					
Supply voltage ( $V_{DD}$ )		3.2	3.3	3.4	V
Supply current ( $I_{DD}$ )			2.3	4	mA

**Accelerometer outputs**

Output voltages	OutP, OutN over full scale	0.14	3.16	V
Differential output	Over full scale	±2.7		V
Resistive load		1000		kΩ
Capacitive load			100	pF

**General**

Reliability assessment	Based on FIDES 2009 Edition A Sept. 2010, available on request.			
------------------------	---	--	--	--

Table 6: MS1100 Specifications

## Absolute maximum ratings

Absolute maximum ratings are stress ratings. Stress in excess of the environmental specifications in the datasheet can cause permanent damage to the device. Exposure to the maximum ratings for an extended period of time may degrade the performance and affect reliability.

Parameter	Comments	Min	Typ	Max	Unit
Supply voltage (V <sub>DD</sub> )		-0.3		+3.9	V
Voltage at any PIN		-0.3		V <sub>DD</sub> +0.3	V
Operational temperature		-40		125	°C
Storage temperature		-55		125	°C
Vibration	Random / 20-2'000Hz			20	g
Shock	Single shock / 0.2ms / 6 directions			1'500	g
ESD stress	HBM model	-1		1	kV

Table 7: Absolute maximum ratings

**Typical performances characteristics**

**MS1002:** Typical initial performances on multiple sensor at 3.3 VDC supply voltage ( $V_{DD}$ ) and ambient temperature for all graphs, unless otherwise stated (multiple sensor: multiple color line / min/max: red line / typical value: green line).

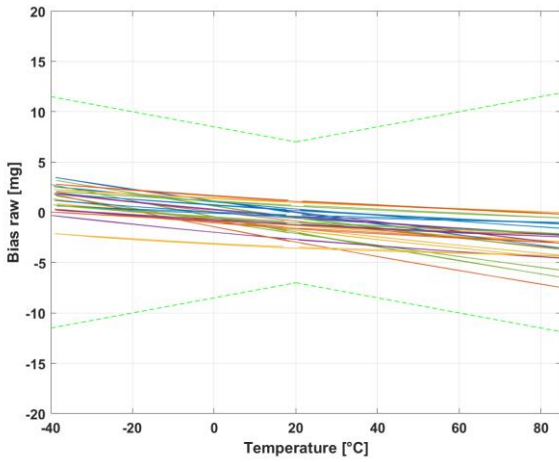

Figure 1: Raw Bias over temperature

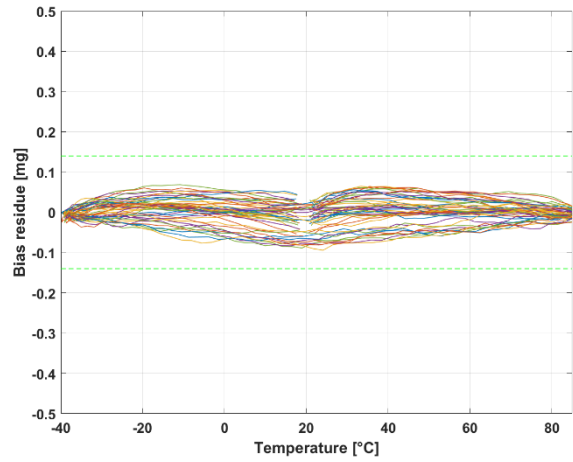

Figure 2 : Residual Bias over temperature

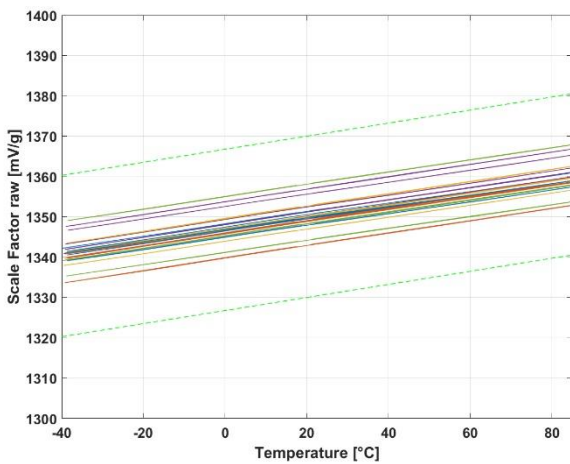

Figure 3: Raw Scale Factor over temperature

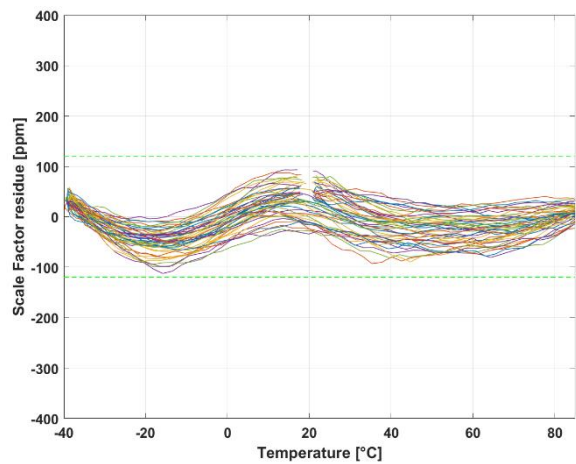

Figure 4: Residual Scale Factor over temperature

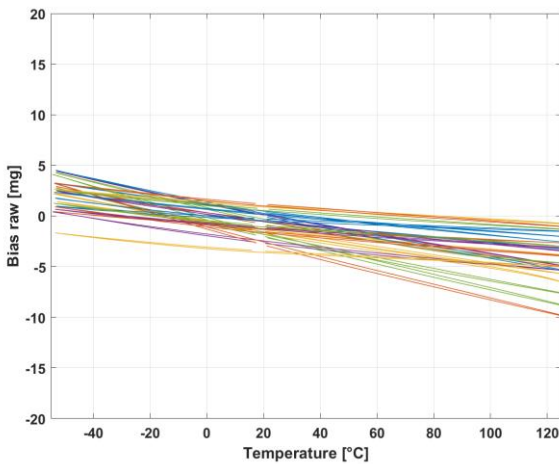

Figure 5: Raw bias over [-55°C to +125°C]

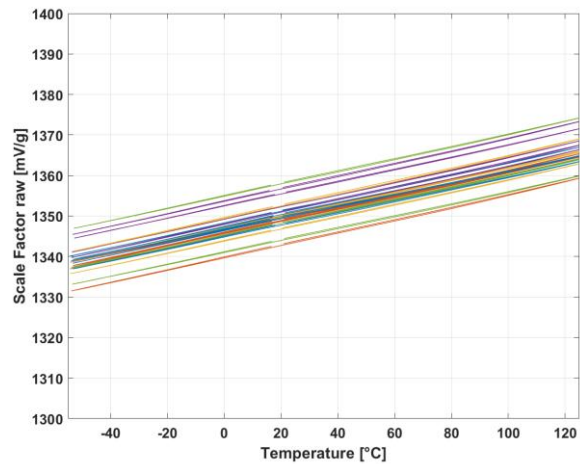

Figure 6: Raw scale factor over [-55°C to +125°C]

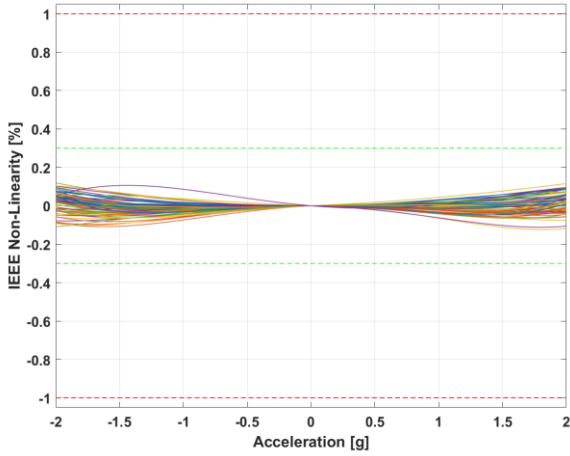

Figure 7 : Non-linearity IEEE

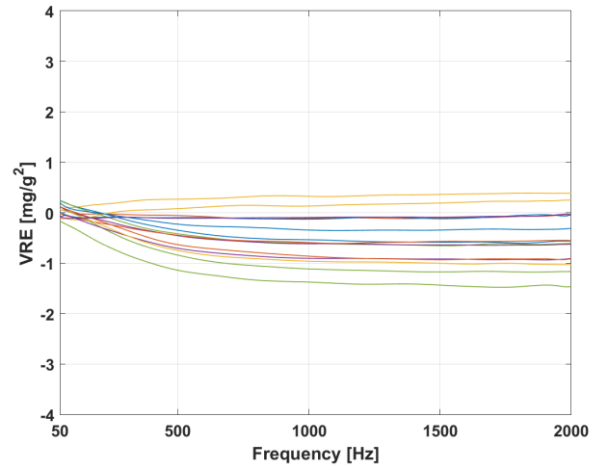

Figure 8: Vibration Rectification Error

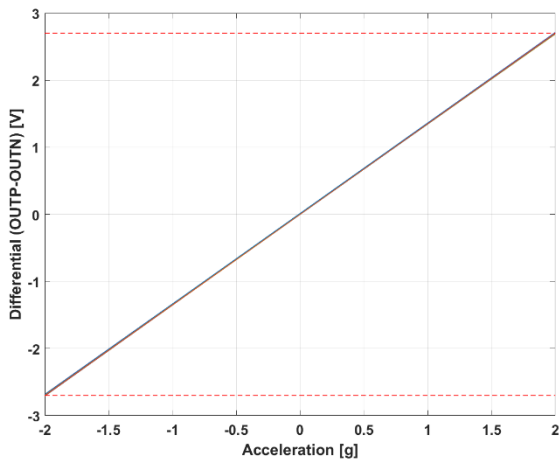

Figure 9 : Differential acceleration output (OUTP-OUTN) at full scale

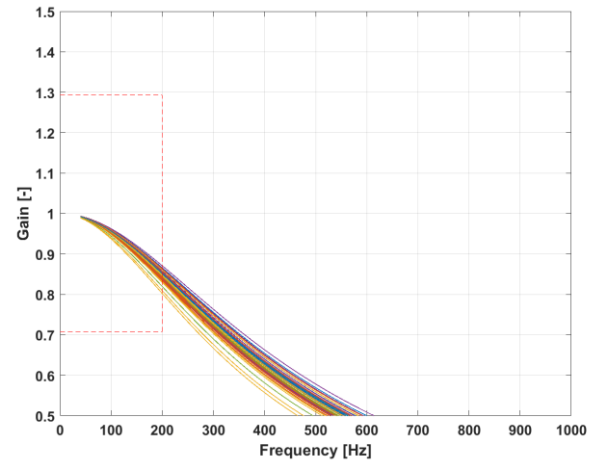

Figure 10 : Frequency response

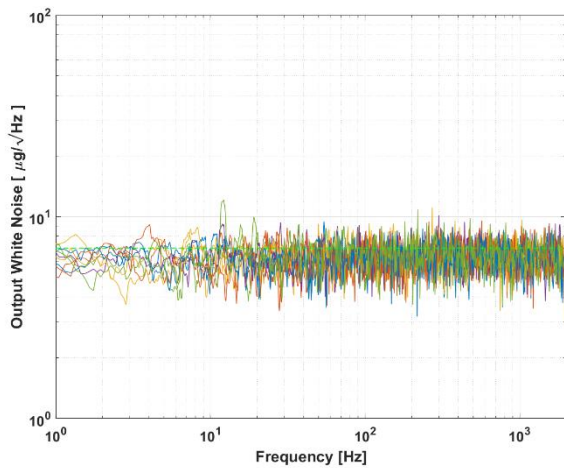

Figure 11: Typical white noise

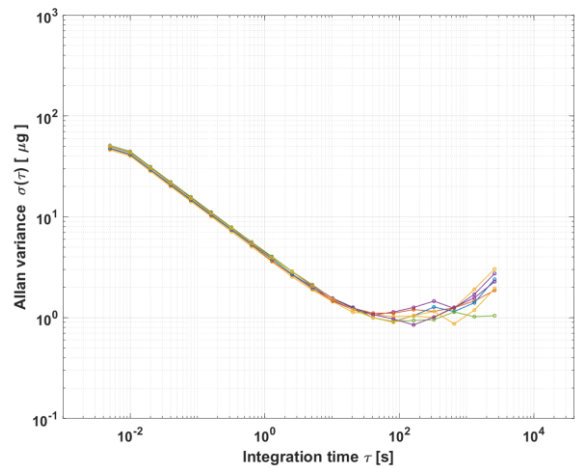

Figure 12: Allan Variance



**MS1005:** Typical initial performances on multiple sensor at 3.3 VDC supply voltage ( $V_{DD}$ ) and ambient temperature for all graphs, unless otherwise stated (multiple sensor: multiple color line / min/max: red line / typical value: green line).

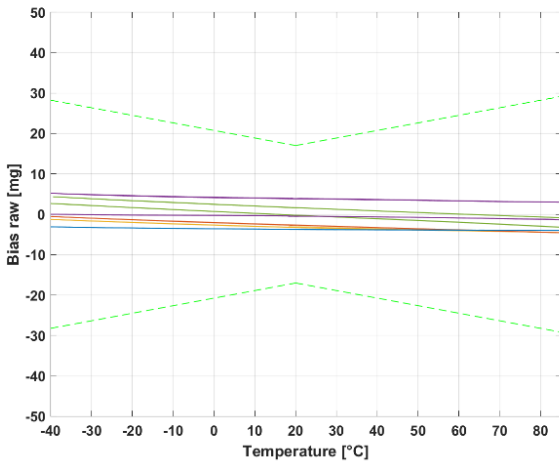

Figure 13: Raw Bias over temperature

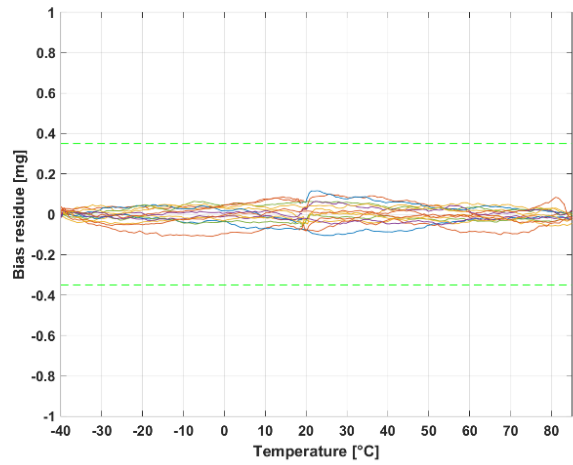

Figure 14 : Residual bias over temperature

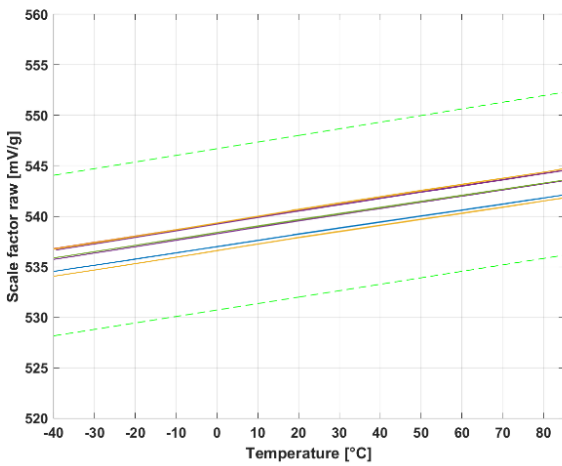

Figure 15: Raw Scale Factor over temperature

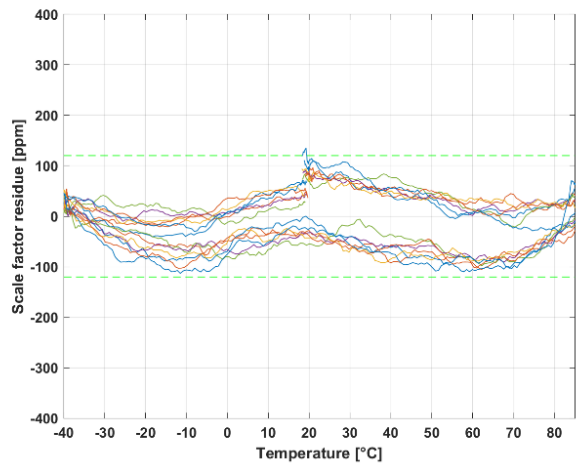

Figure 16: Residual Scale Factor over temperature

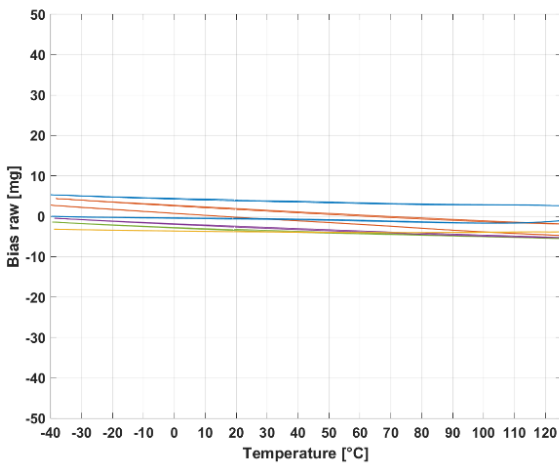

Figure 17: Raw bias over [-55°C to +125°C]

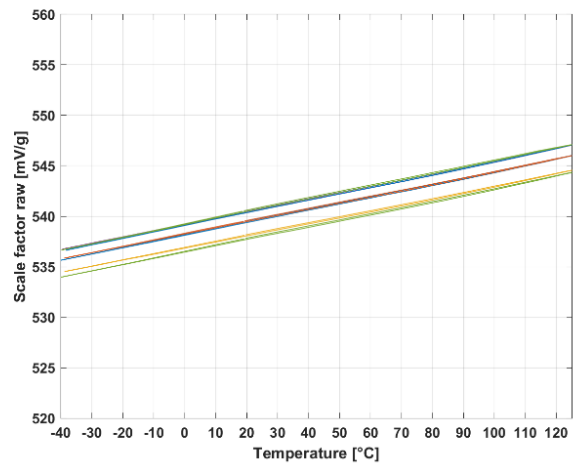

Figure 18: Raw scale factor over [-55°C to +125°C]

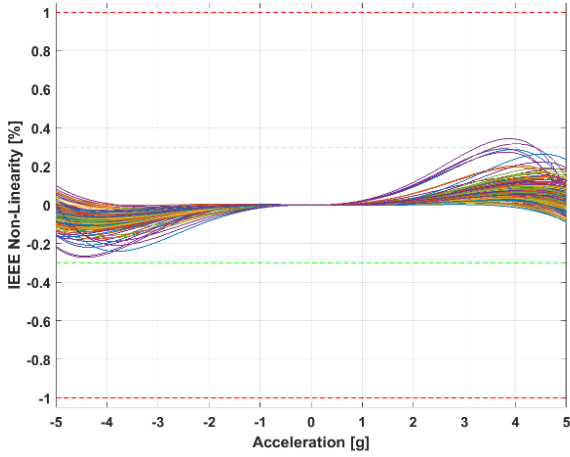

Figure 19 : Non-linearity IEEE

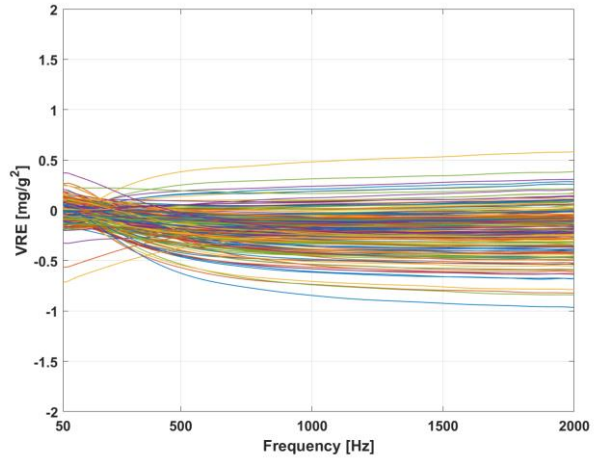

Figure 20: Vibration Rectification Error

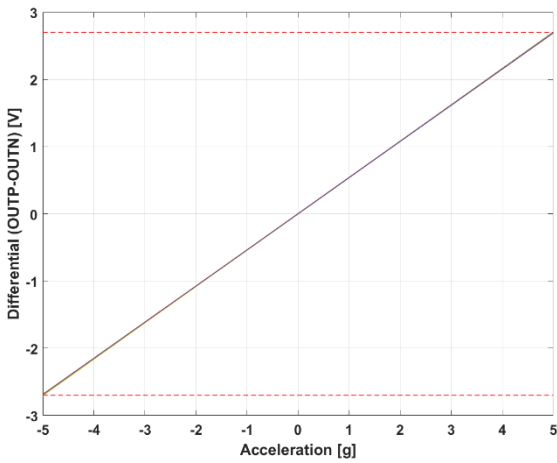

Figure 21 : Differential acceleration output (OUTP-OUTN) at full scale

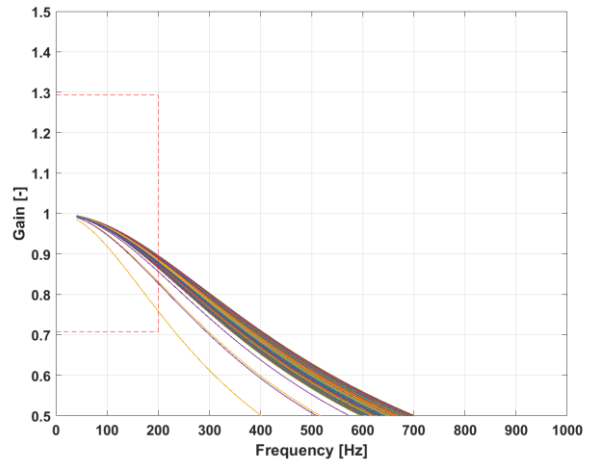

Figure 22 : Frequency response

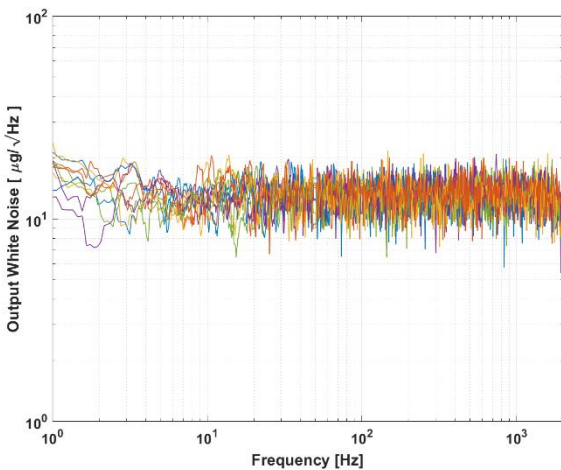

Figure 23: Typical white noise

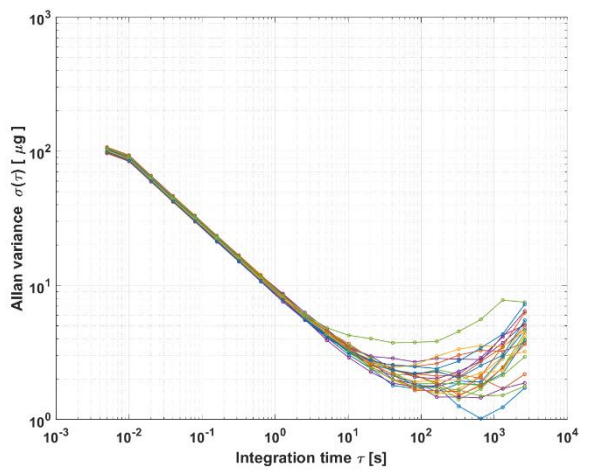

Figure 24: Allan Variance

**MS1010:** Typical initial performances on multiple sensor at 3.3 VDC supply voltage ( $V_{DD}$ ) and ambient temperature for all graphs, unless otherwise stated (multiple sensor: multiple color line / min/max: red line / typical value: green line).

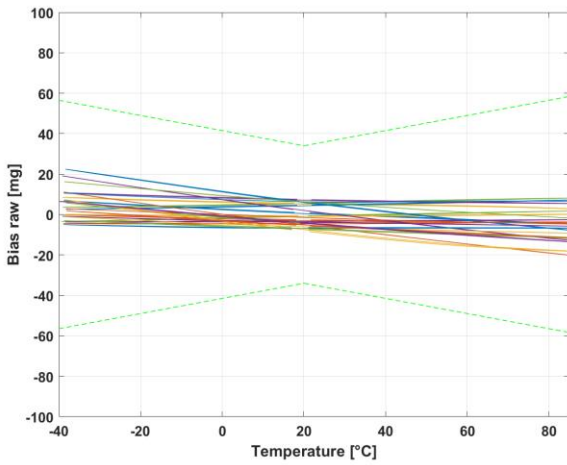

Figure 25: Raw Bias over temperature

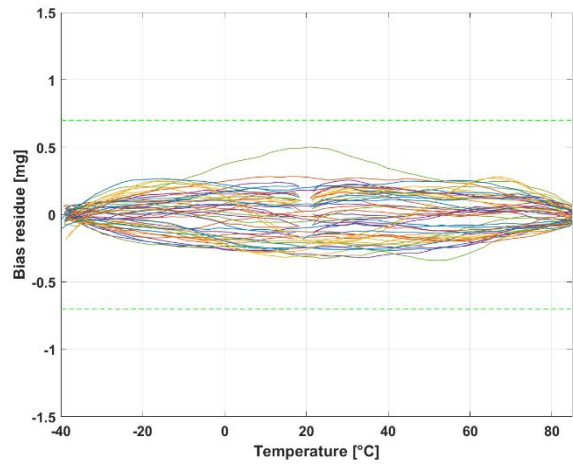

Figure 26 : Residual Bias over temperature

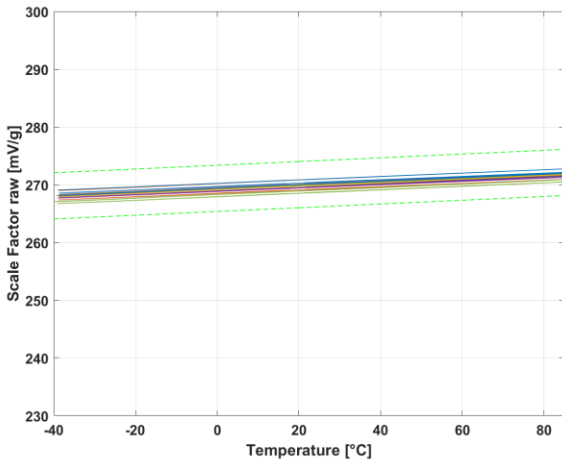

Figure 27: Raw Scale Factor over temperature

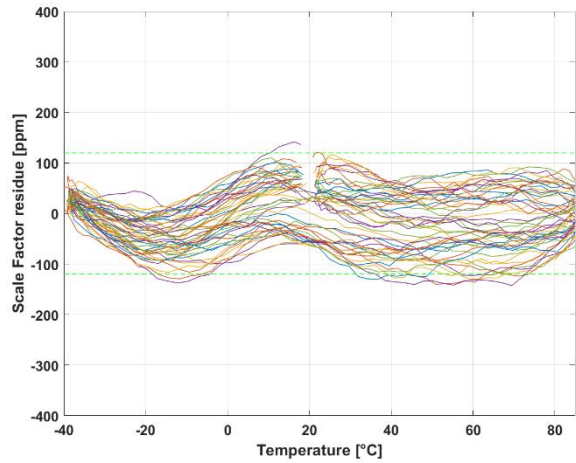

Figure 28: Residual Scale Factor over temperature

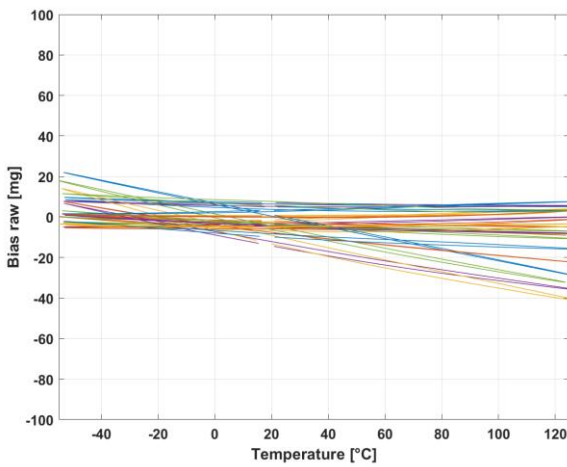

Figure 29: Raw bias over [-55°C to +125°C]

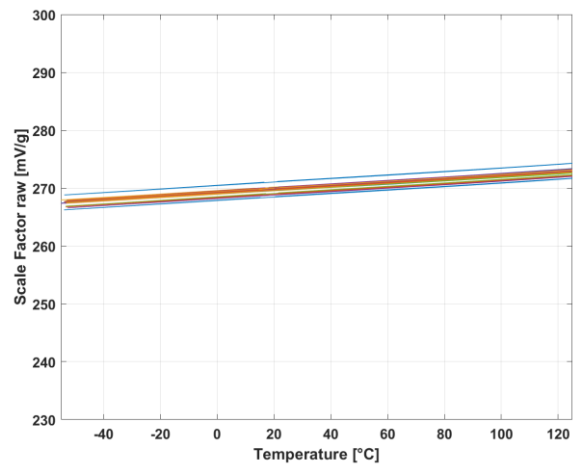

Figure 30: Raw scale factor over [-55°C to +125°C]

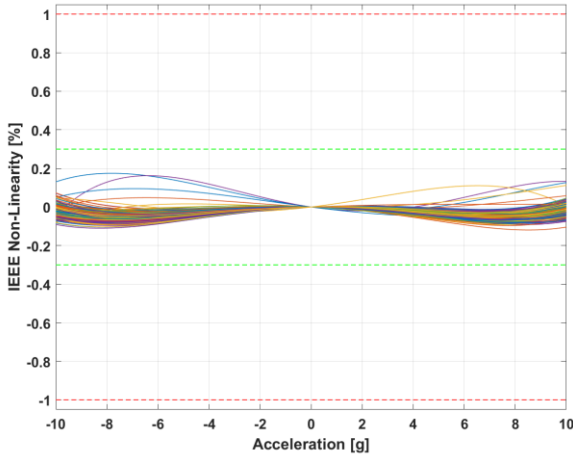

Figure 31 : Non-linearity IEEE

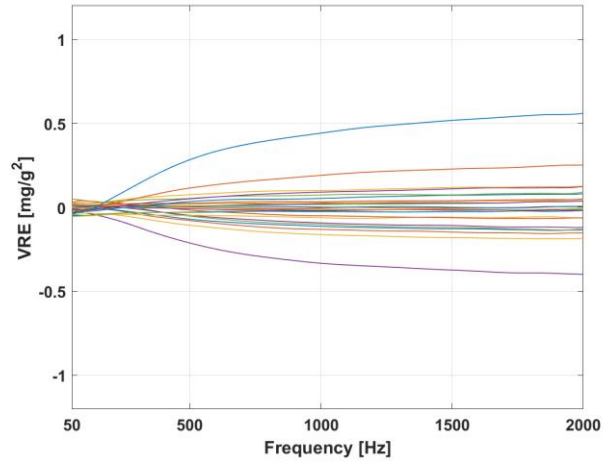

Figure 28: Vibration Rectification Error

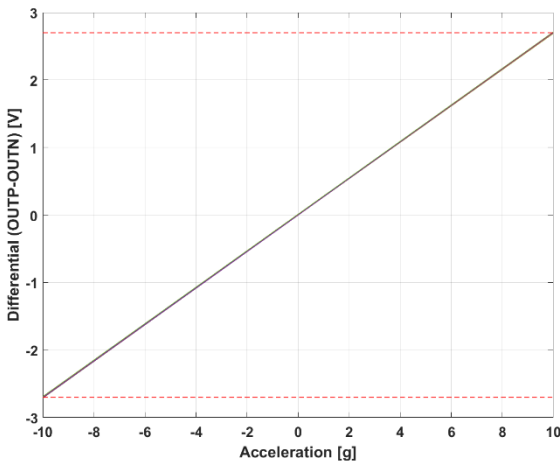

Figure 32 : Differential acceleration output (OUTP-OUTN) at full scale

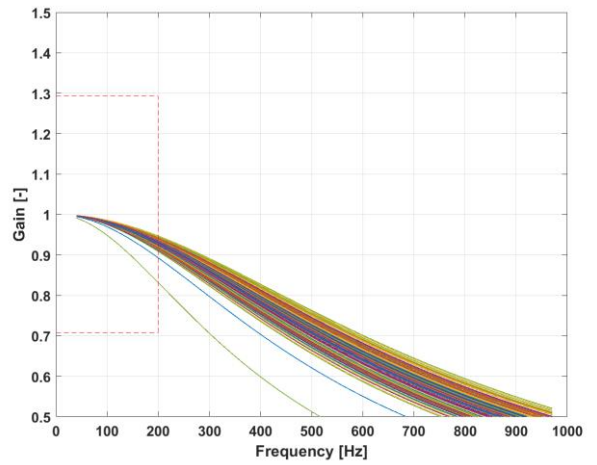

Figure 33 : Frequency response

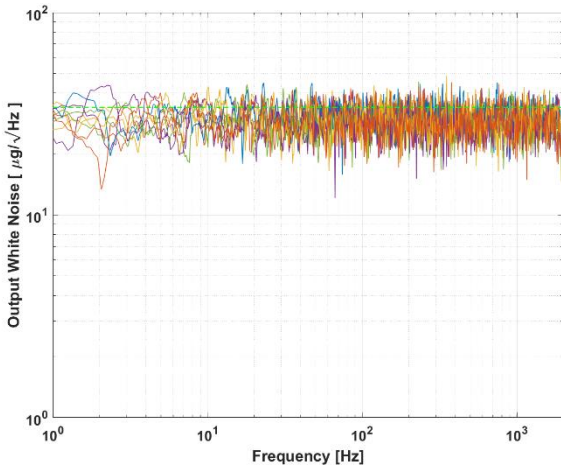

Figure 34: Typical white noise

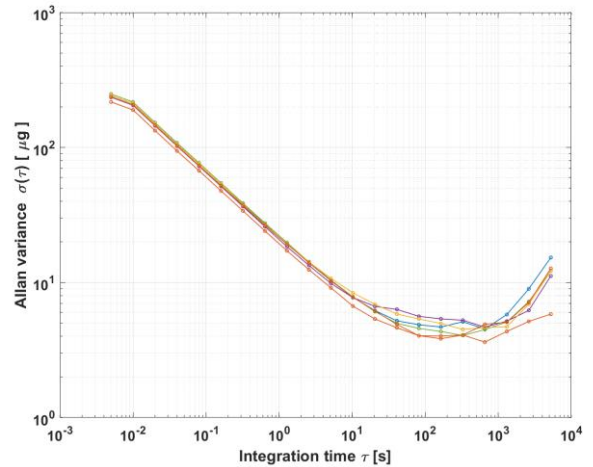

Figure 35: Allan Variance

**MS1016:** Typical initial performances on multiple sensor at 3.3 VDC supply voltage ( $V_{DD}$ ) and ambient temperature for all graphs, unless otherwise stated (multiple sensor: multiple color line / min/max: red line / typical value: green line).

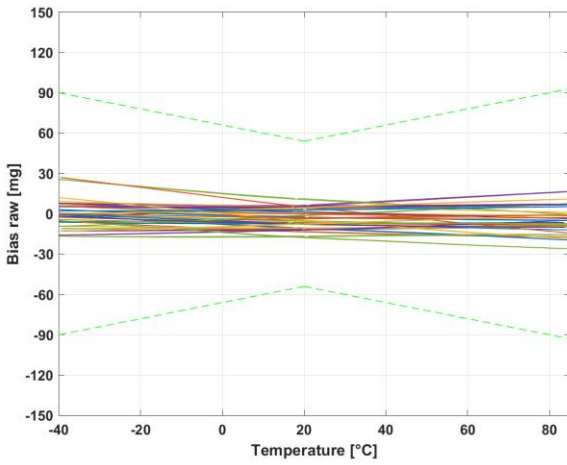

Figure 36: Raw bias over temperature

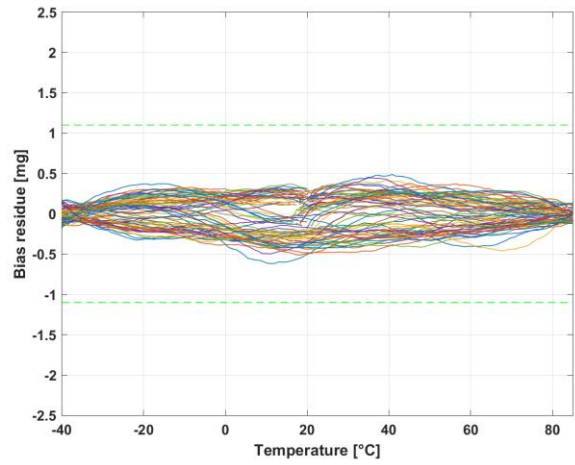

Figure 37: Residual bias over temperature

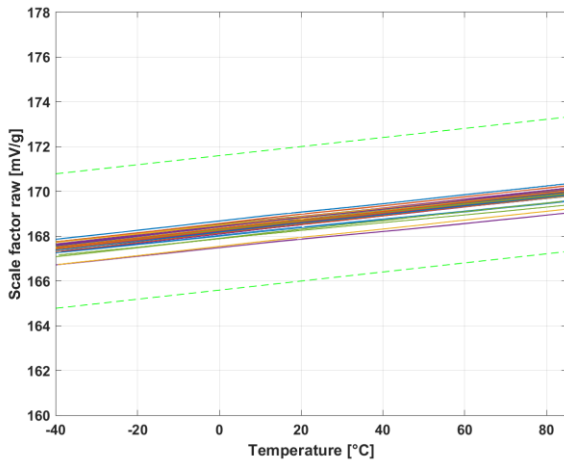

Figure 38: Raw Scale Factor over temperature

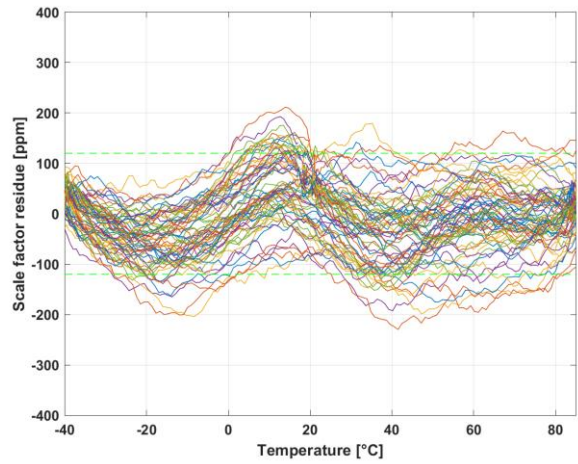

Figure 39: Residual Scale Factor over temperature

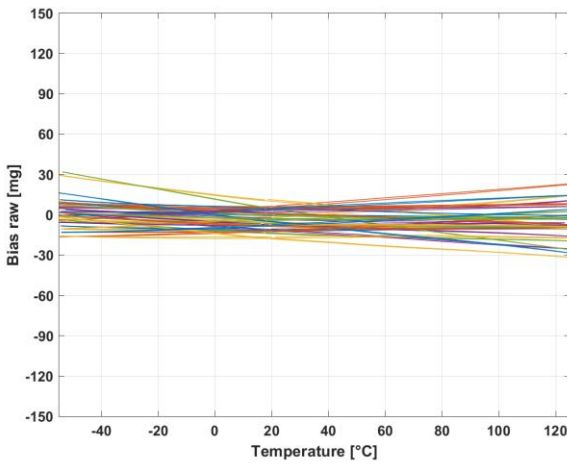

Figure 40: Raw bias over [-55°C to +125°C]

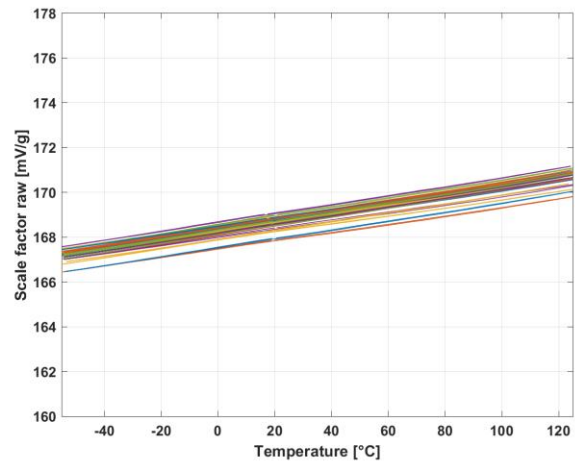

Figure 41: Raw scale factor over [-55°C to +125°C]

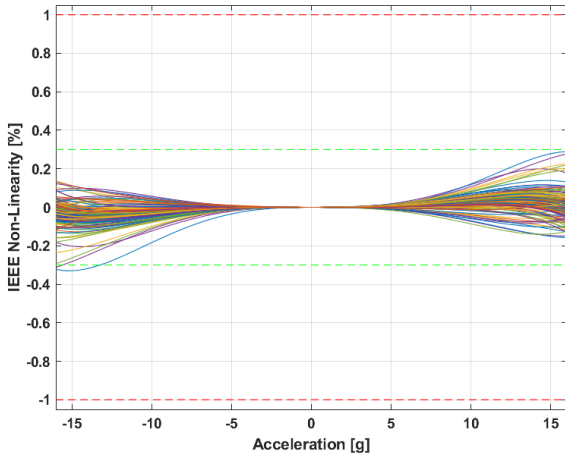

Figure 42 : Non-linearity IEEE

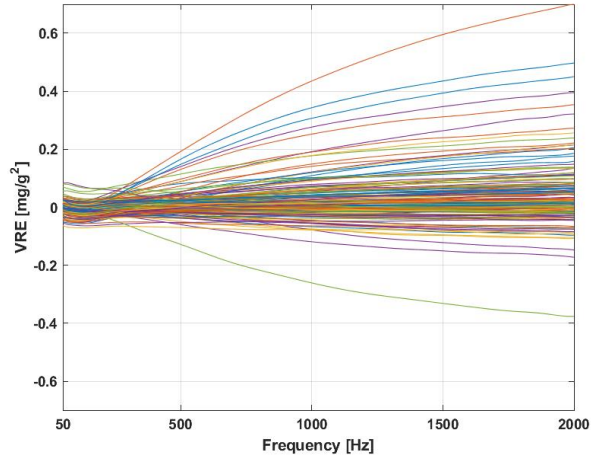

Figure 43: Vibration Rectification Error

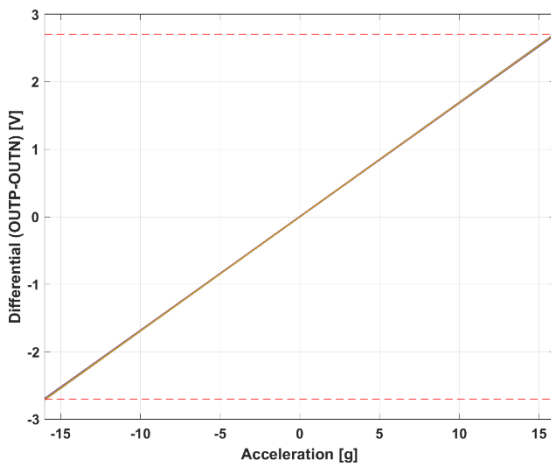

Figure 44 : Differential acceleration output (OUTP-OUTN) at full scale

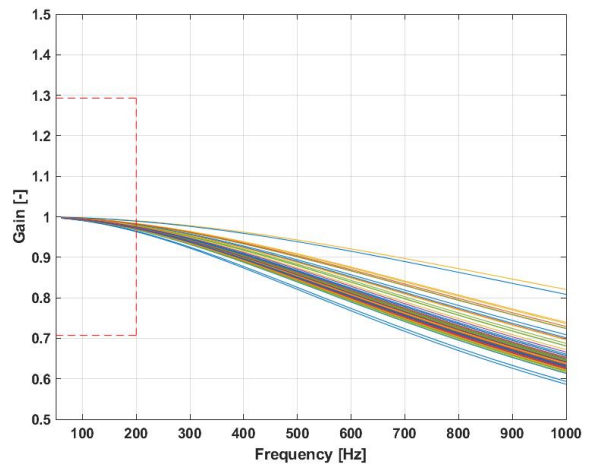

Figure 45 : Frequency response

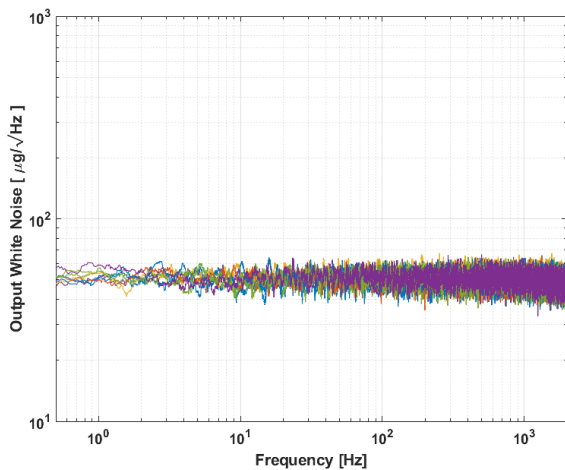

Figure 46: Typical white noise

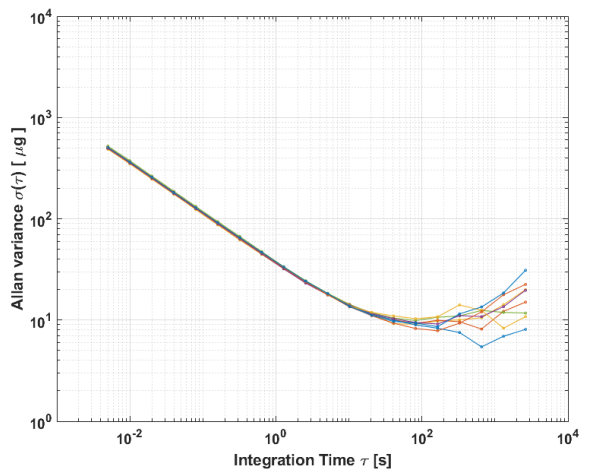

Figure 47: Allan Variance

**MS1030:** Typical initial performances on multiple sensor at 3.3 VDC supply voltage (V<sub>DD</sub>) and ambient temperature for all graphs, unless otherwise stated (multiple sensor: multiple color line / min/max: red line / typical value: green line).

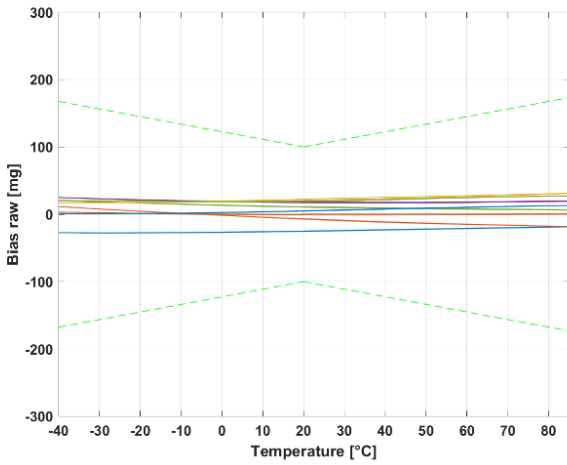

Figure 48: Raw bias over temperature

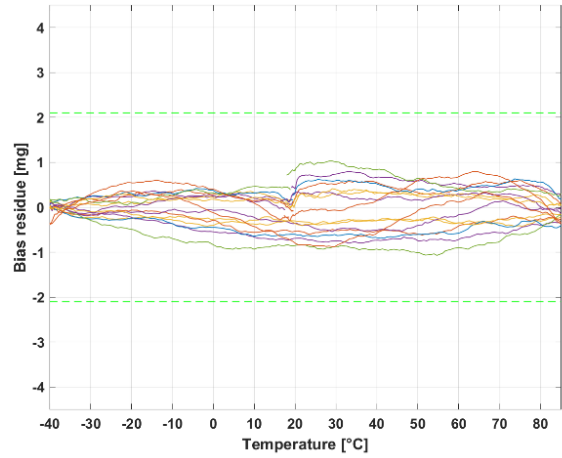

Figure 49: Residual bias over temperature

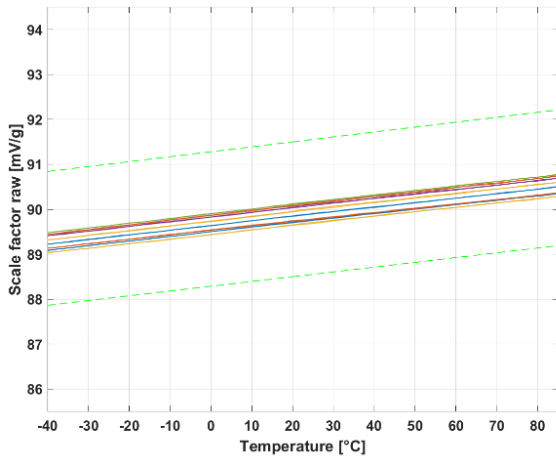

Figure 50: Raw Scale Factor over temperature

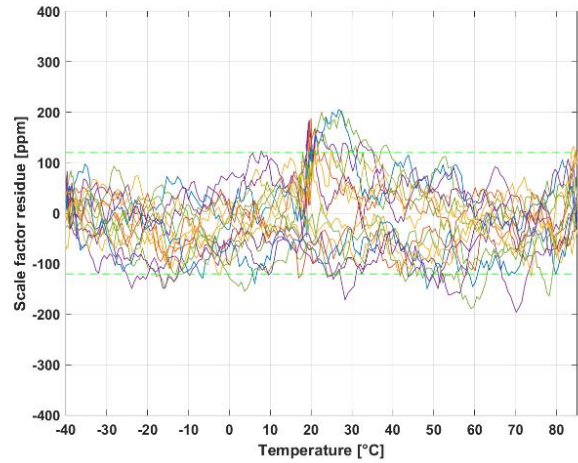

Figure 51: Residual Scale Factor over temperature

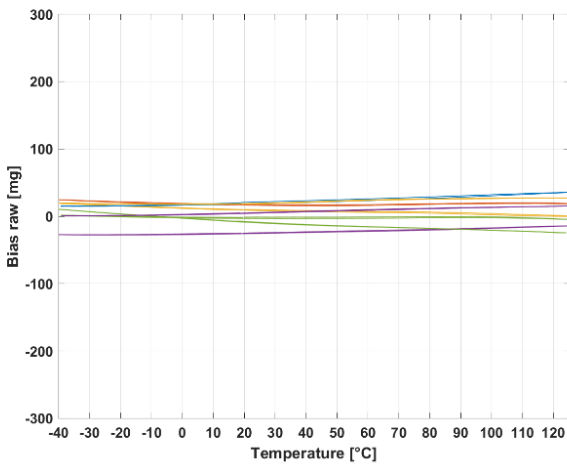

Figure 52: Raw bias over [-55°C to +125°C]

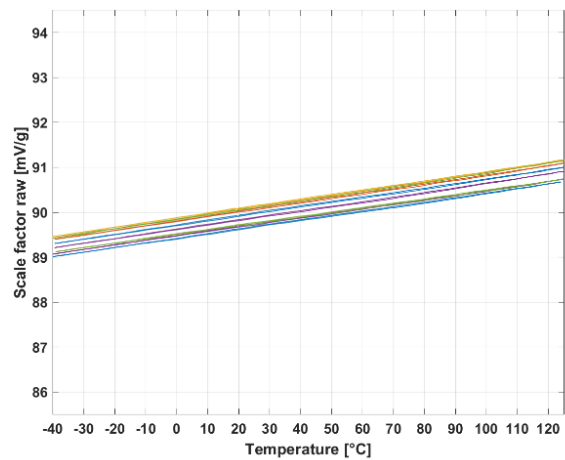

Figure 53: Raw scale factor over [-55°C to +125°C]

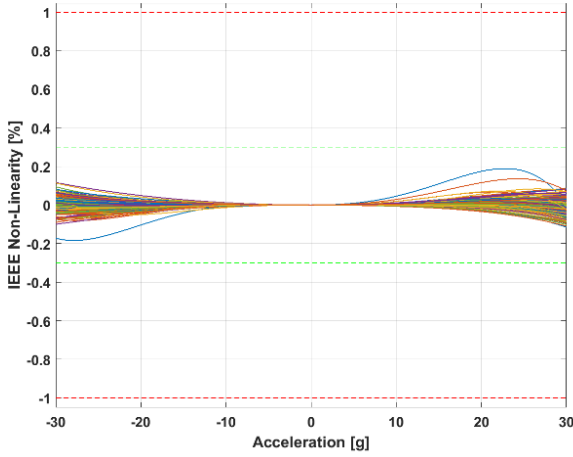

Figure 54 : Non-linearity IEEE

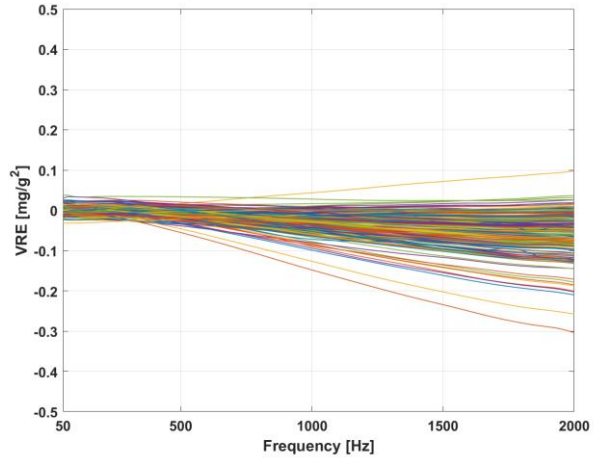

Figure 55: Vibration Rectification Error

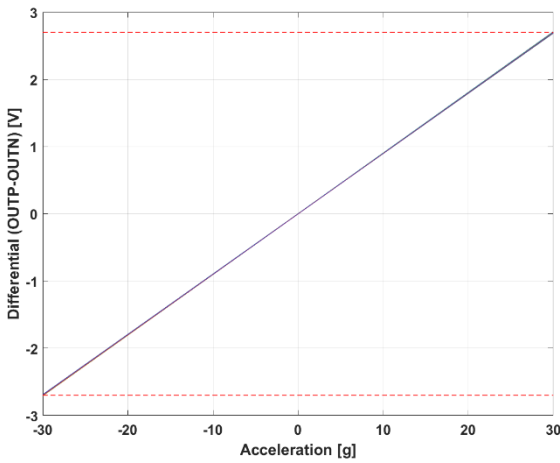

Figure 56 : Differential acceleration output (OUTP-OUTN) at full scale

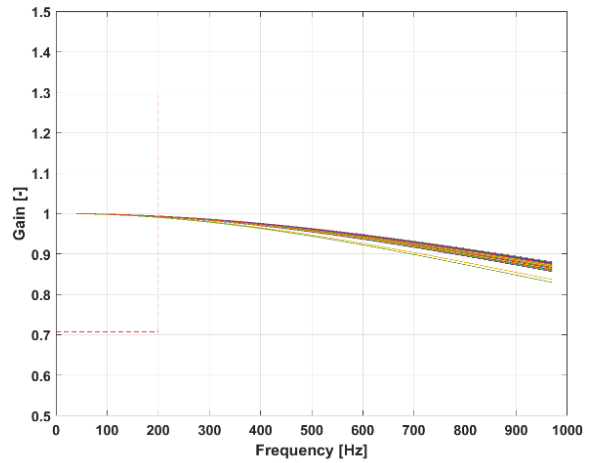

Figure 57 : Frequency response

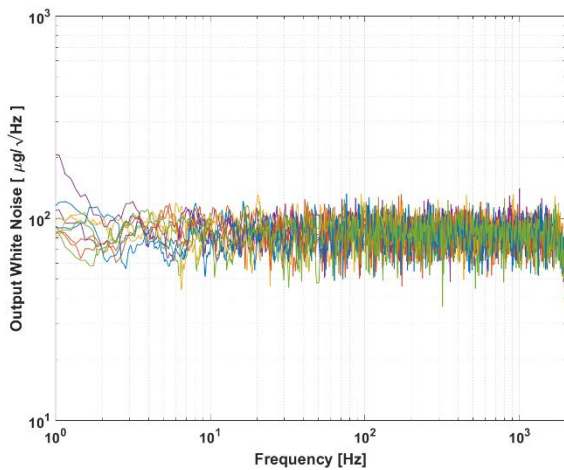

Figure 58: Typical white noise

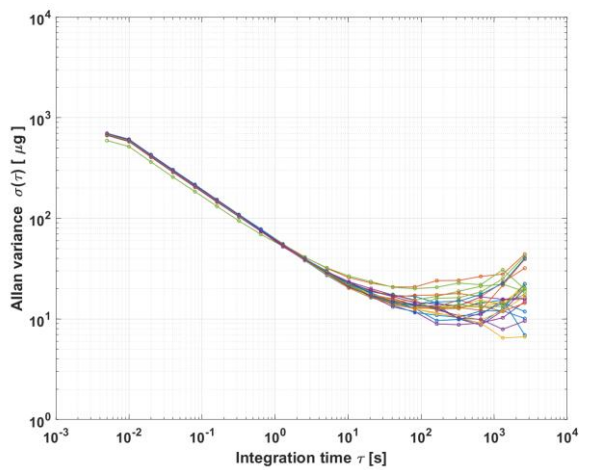

Figure 59: Allan Variance



**MS1100:** Typical initial performances on multiple sensor at 3.3 VDC supply voltage ( $V_{DD}$ ) and ambient temperature for all graphs, unless otherwise stated (multiple sensor: multiple color line / min/max: red line / typical value: green line).

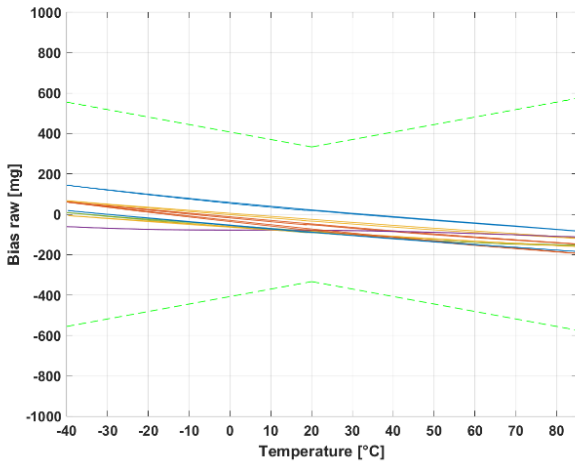

Figure 60: Raw bias over temperature

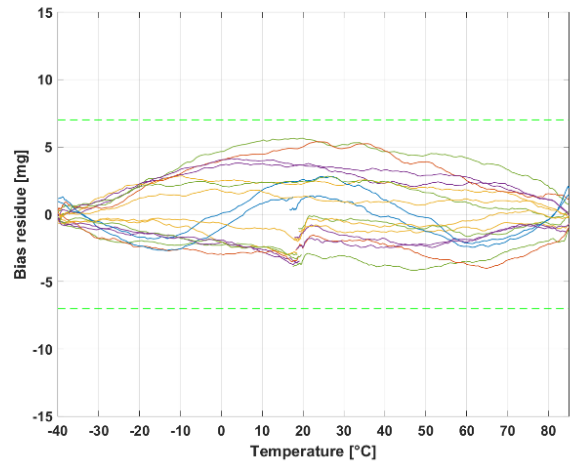

Figure 61 : Residual bias over temperature

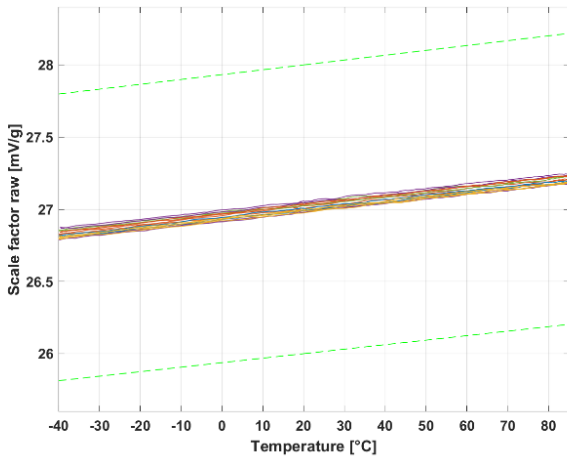

Figure 62: Raw Scale Factor over temperature

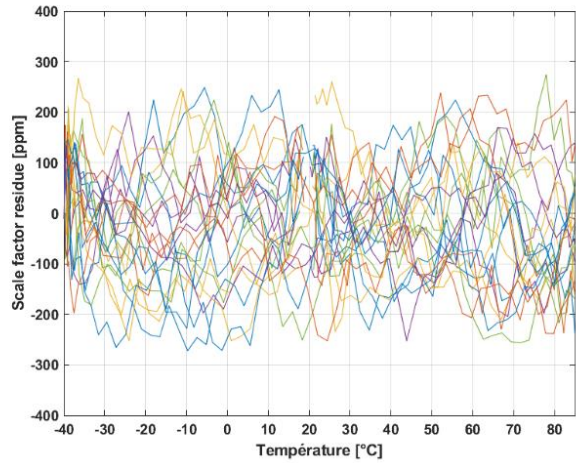

Figure 63: Residual Scale Factor over temperature

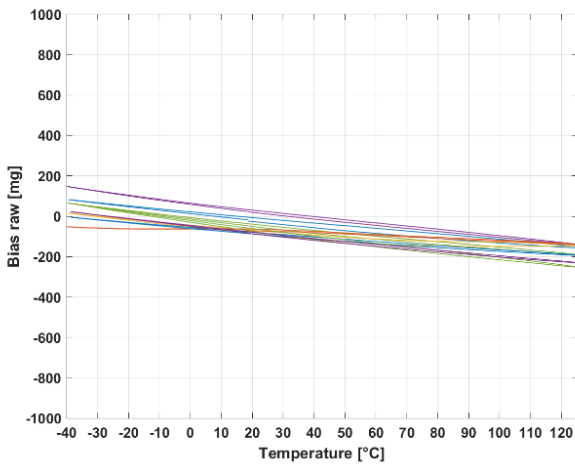

Figure 64: Raw bias over [-55°C to +125°C]

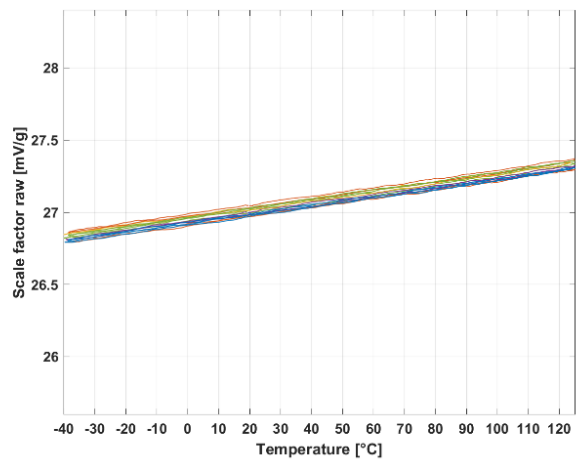

Figure 65: Raw scale factor over [-55°C to +125°C]

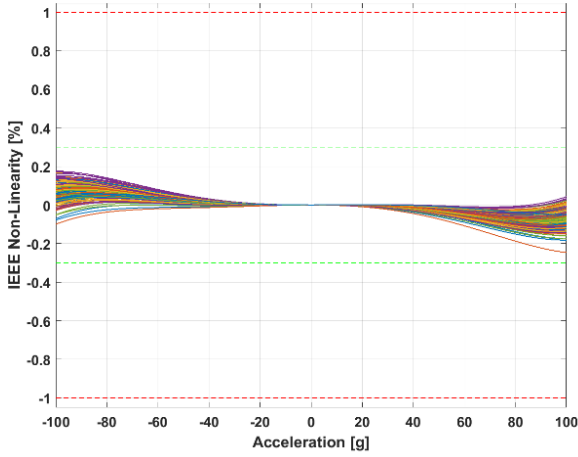

Figure 66 : Non-linearity IEEE

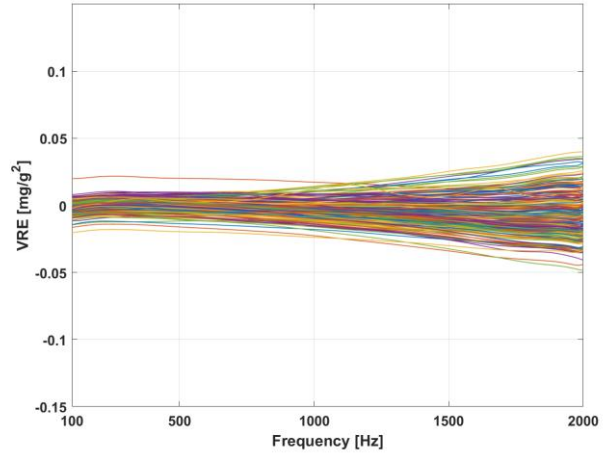

Figure 67: Vibration Rectification Error

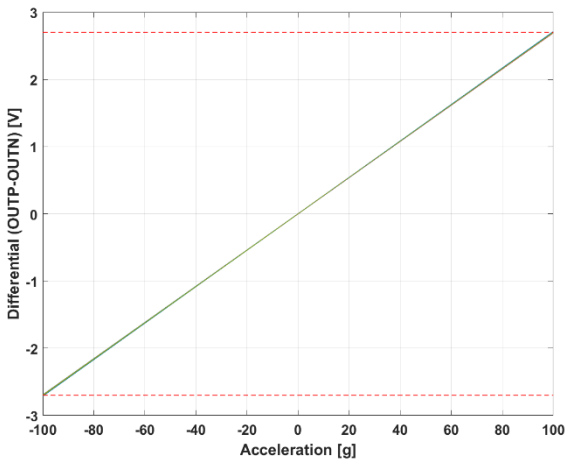

Figure 68 : Differential acceleration output (OUTP-OUTN) at full scale

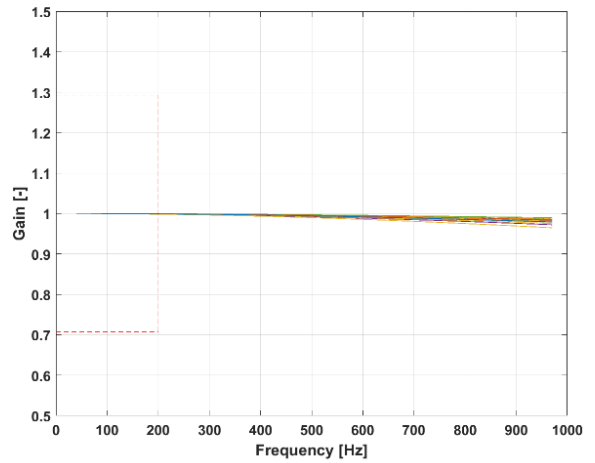

Figure 69 : Frequency response

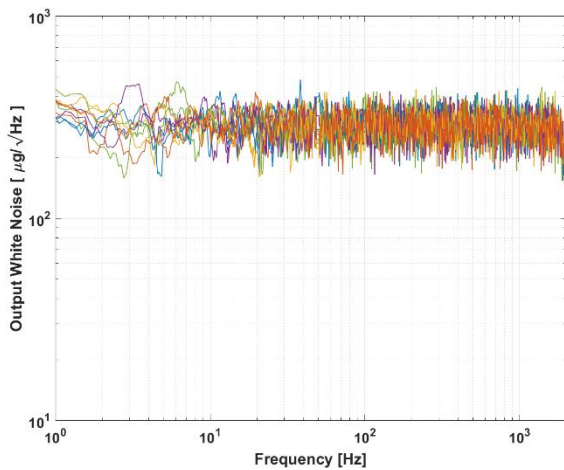

Figure 70: Typical white noise

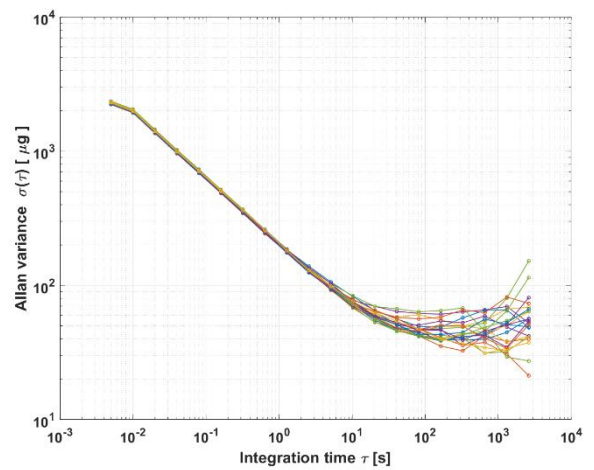

Figure 71: Allan Variance

Pinout description

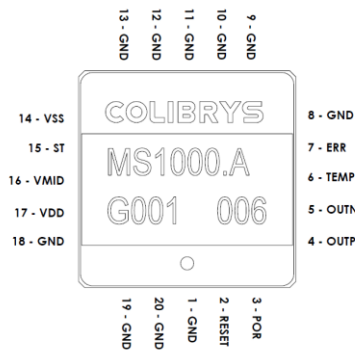

Figure 72: Pinout top view

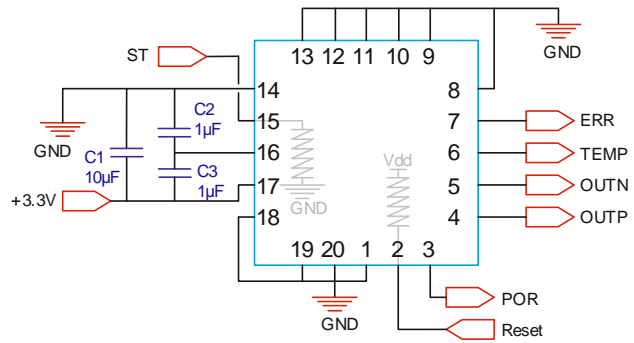

Figure 73: Proximity circuit & internal pull-up/down

The device pin layout is given in Figure 72 and a description of each pin given in the Table 8. The capacitors C1 (10 µF), C2 (1 µF) and C3 (1 µF) are shown in Figure 73 and must be placed as close as possible to the MS1000 package and are used as decoupling capacitors and for a proper sensor startup.

Pin Nb.	Pin name	Type	Description
2	RESET	LI, PU	System reset signal, active low
3	POR	LO	Power On Reset
4	OUTP	AO	Differential output positive signal
5	OUTN	AO	Differential output negative signal
6	TEMP	AO	Temperature analogue output
7	ERR	LO	Error signal (flag)
14	V <sub>SS</sub> (0 V)	PWR	Connect to ground plane
15	ST	LI, PD	Self-test activation, active high
16	V <sub>MID</sub>	AO	Internal electronic circuit reference voltage. For decoupling capacitors only
17	V <sub>DD</sub> (3.3 V)	PWR	Analogue power supply
1,8,9,10,11,12,13,18,19,20	GND	GND	Must be connected to ground plane (GND)

*PWR, power / AO, analog output / AI, analog input / LO, logical output / LI, logical input / PD, internal pull down / PU, internal pull up*

Table 8: MS1000 pinout description

## Electrical Functions description

### Introduction

MS1000 has electrical logic function embedded such as Power-On-Reset, External reset, Built in Self-test and Overload error detection. All those functions are described below.

### POR (Power-On-Reset) function

The POR block continuously monitors the power supply during startup as well as normal operation. It ensures a proper startup of the sensor and acts as a brownout protection in case of a drop in supply voltage.

During sensor power on, the POR signal stays low until the supply voltage reaches the POR threshold voltage ( $V_{TH}$ ) and begins the startup sequence (see Figure 74). In case of a supply voltage drop, the POR signal will stay low until the supply voltage exceeds  $V_{TH}$  and is followed by a new startup sequence. The ERR signal is high (equal to  $V_{DD}$ ) until the startup sequence is complete.

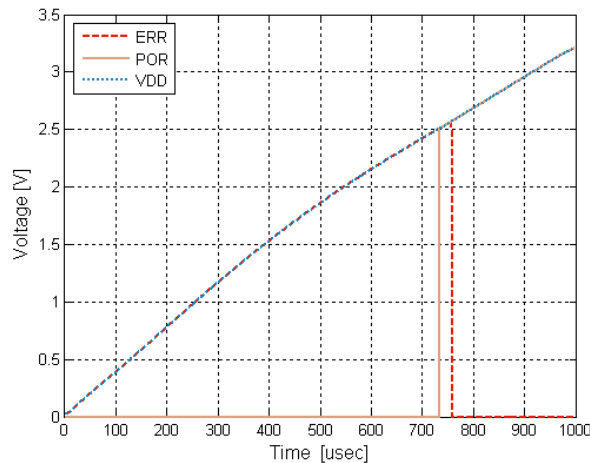

Figure 74: Typical sensor power sequence using the recommended circuit

### External Reset

An external reset can be activated by the user through the RESET input pin. During a reset phase, the accelerometer outputs (OUTP & OUTN) are forced to  $V_{DD} / 2$  and the error signal (ERR) is activated (high), see Figure 75.

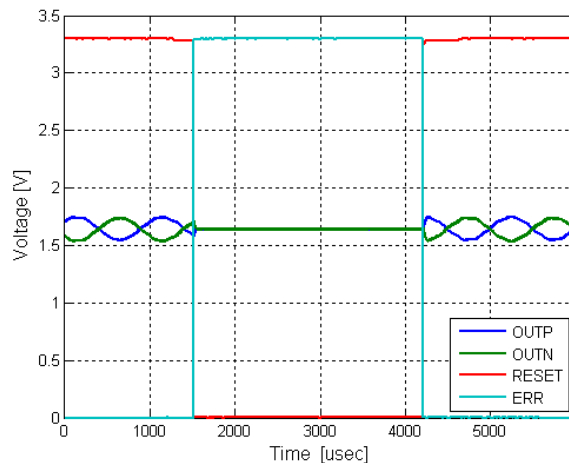

Figure 75: Typical sensor reset sequence with external reset

**Built-in Self-Test function**

The built-in Self-Test mode generates a square wave signal on the device outputs (OUTP & OUTN) and can be used for device failure detection (see Figure 76).

When activated, it induces an alternating electrostatic force on the mechanical sensing element and emulates an input acceleration at a defined frequency. This electrostatic force is in addition to any inertial acceleration acting on the sensor during self-test; therefore it is recommended to use the self-test function under quiescent conditions.

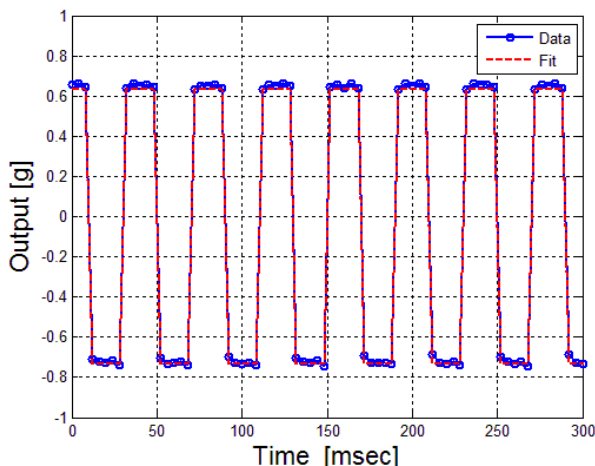

Figure 76: Built-in Self-Test signal on the differential acceleration output (frequency: 24 Hz / amplitude 1.3 g)

**Overload and error function**

The device continuously monitors the validity of the accelerometer output signals. If an error occurs, the ERR pin goes high and informs the user that the output signals are not valid. An error can be raised in the following cases:

- Out-of-tolerance power supply voltage (POR low), such as during power on
- During external reset phase (user activation of the reset)
- Under high acceleration overload (e.g. high shock)

Upon a high-amplitude shock, the internal overload circuit resets the electronics and initiates a new startup of the readout electronics. This sequence is repeated until the acceleration input signal returns to normal operation range. This behavior is illustrated on the figure below with a large shock of amplitude 500 g: the overload protection is active during the shock and the sensor is fully operational once the acceleration is within the operating range

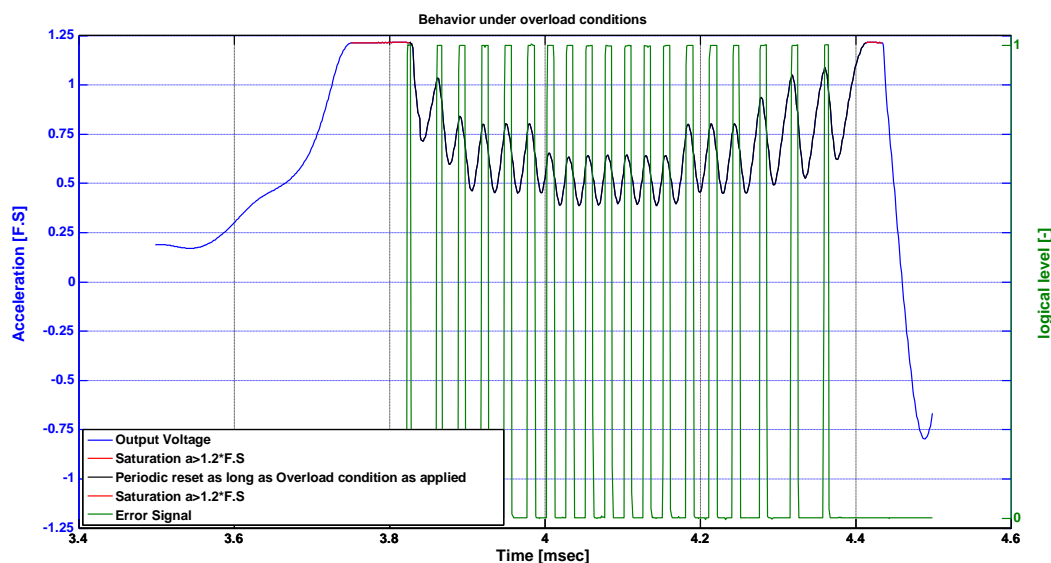

Figure 77: Overload Behavior

## Dimensions and package specifications

The outline of the LCC20 ceramic package and the Center of Gravity (CG) is illustrated in the Figure 78.

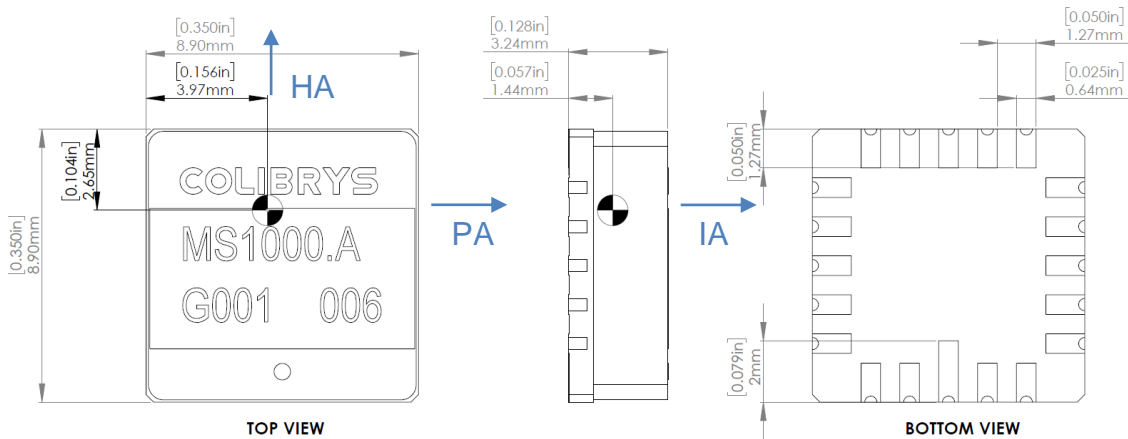

Figure 78: Package mechanical dimension. Units are mm [inch]

Parameter	Comments	Min	Typ	Max	Unit
Lead finishing	Au plating	0.5		1.5	µm
	Ni plating	1.27	4	8.89	µm
	W (tungsten)	10		15	µm
Hermeticity	According to MIL-STD-883-G			5·10 <sup>-8</sup>	atm·cm <sup>3</sup> /s
Weight				1.5	grams
Size	X		8.9	9.2	mm
	Y		8.9	9.2	mm
	Z		3.23	3.5	mm
Packaging	RoHS compliant part. Nonmagnetic, LCC20 pin housing.				
Proximity effect	The sensor is sensitive to external parasitic capacitance. Moving metallic objects with large mass or parasitic effect in close proximity of the accelerometer (mm range) must be avoided to ensure best product performances. A ground plane below the accelerometer is recommended as a shielding.				
Reference plane for axis alignment	LCC must be tightly fixed to the circuit board, using the bottom of the housing as the reference plane for axis alignment. Using the lid as reference plane or for assembly may affect specifications and product reliability (i.e. axis alignment and/or lid soldering integrity)				

Table 9: Package specifications

## Recommended circuit

In order to obtain the best device performance, particular attention must be paid to the proximity analog electronics. A proposed circuit that includes a reference voltage, the sensor decoupling capacitors and output buffers is described in Figure 79.

Optimal acceleration measurements are obtained using the differential output (OUTP – OUTN). If a single-ended acceleration signal is required, it must be generated from the differential acceleration output in order to remove the common mode noise.

### Block Diagram & Schematic

The main blocks that require particular attention are the power supply management, the accelerometer sensor electronic and the output buffer. The following schematic shows an example of MS1000 implementation.

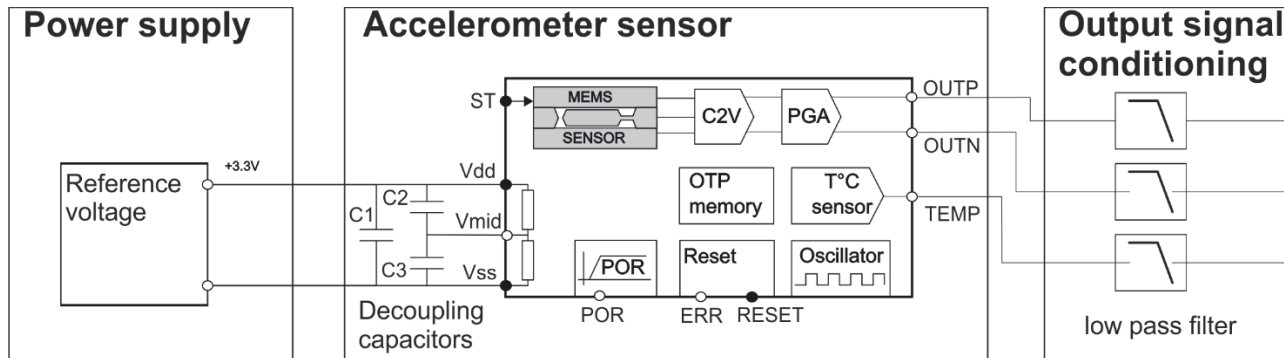

Figure 79: Recommended Block diagram

### Power Supply

The accelerometer output is ratiometric to the power supply voltage and its performance will directly impact the accelerometer bias, scale factor, noise or thermal performance. Therefore, a low-noise, high-stability and low-thermal drift power supply is recommended. Key performance should be:

- Output noise <  $1\mu\text{V}/\sqrt{\text{Hz}}$
- Output temperature coefficient <  $10\text{ppm}/^\circ\text{C}$

The power supply can be used as an output signal in order to compensate any variation on the power supply voltage that will impact the accelerometer signal (ratiometric output).

The electronic circuit within the accelerometer is based on a switched-capacitor architecture clocked at 200 kHz. High-frequency noise or spikes on the power supply will affect the outputs and induce a signal within the device bandwidth.

### Accelerometer sensor

The sensor block is composed of the MS1000 accelerometer and the 3 decoupling capacitors: C1 [10 $\mu\text{F}$ ], C2 [1 $\mu\text{F}$ ] and C3 [1 $\mu\text{F}$ ]. These capacitors are mandatory for the proper operation and full performance of the accelerometer. We recommend placing them as close as possible to the MS1000 package on the printed circuit board.

### Output signal conditioning

The output signal must be correctly filtered and buffered before data acquisition. We recommend using an ultra-low offset, drift and bias current operational amplifier that match the MS1000 output impedance and a second order low pass filter (LPF) to prevent aliasing of the high frequency noise signal. A second order filter with a 4 kHz cut off frequency will attenuate the noise at 200 kHz by 70dB.

### SMD recommendation

A recommended land pattern for LCC20 is shown in the Figure 80. It should be tested and qualified in the manufacturing process. The land pattern and pad sizes have a pitch of 1.27mm and the pin 1 is longer to ensure the right orientation of the product during mounting. After assembly, the orientation can be controlled from the top with an extra point printed on the lid which correspond to pin 1.

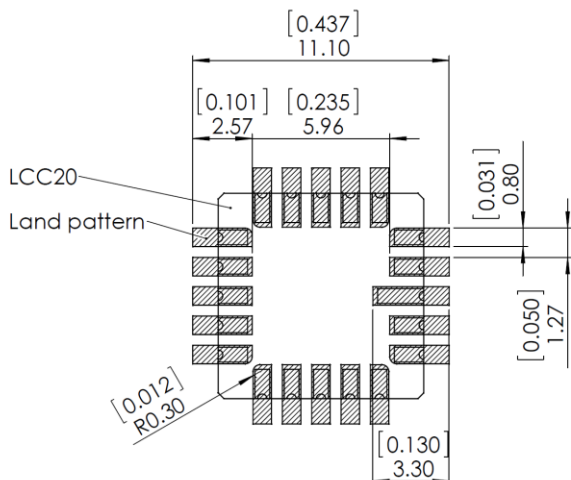

Figure 80 : LCC20 land pattern recommendation (unit are mm/[inch])

The MS1000 is suitable for Sn/Pb and Pb-Free soldering and ROHS compliant. Typical temperature profiles recommended by the solder manufacturer can be used with a maximum ramp-up of 3°C/second and a maximum ramp-down of 6°C/second: The exact profile depends on the used solder paste.

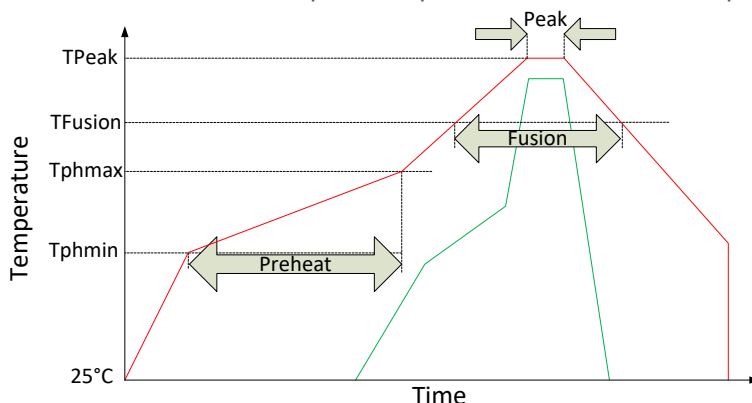

Figure 81: Soldering Temperature Profile

Phase	Sn/Pb		Pb-Free	
	Duration [sec]	Temperature [°C]	Duration [sec]	Temperature [°C]
Peak	10-30	235-240	20-40	245-250
Fusion	60-150	183	60-150	217
Preheat	60-120	Min : 100 Max : 150	60-180	Min : 150 Max : 200

Table 10: Soldering temperatures & times

The cleaning process of electronic boards sometimes involves ultrasounds. This is strongly prohibited on our sensors. Ultrasonic cleaning will have a negative impact on silicon elements which generally causes damages.



**Note: Ultrasonic cleaning is forbidden in order to avoid damage of the MEMS accelerometer**



## Handling and packaging precautions

### Handling

The MS1000 is packaged in a hermetic ceramic housing to protect the sensor from the ambient environment. However, poor handling of the product can induce damage to the hermetic seal (Glass frit) or to the ceramic package made of brittle material (alumina). It can also induce internal damage to the MEMS accelerometer that may not be visible and cause electrical failure or reliability issues. Handle the component with caution: shocks, such as dropping the accelerometer on hard surface, may damage the product.



**It is strongly recommended to use vacuum pens to manipulate the accelerometers**

The component is susceptible to damage due to electrostatic discharge (ESD). Therefore, suitable precautions shall be employed during all phases of manufacturing, testing, packaging, shipment and handling. Accelerometer will be supplied in antistatic bag with ESD warning label and they should be left in this packaging until use. The following guidelines are recommended:

- Always manipulate the devices in an ESD-controlled environment
- Always store the devices in a shielded environment that protects against ESD damage (at minimum an ESD-safe tray and an antistatic bag)
- Always wear a wrist strap when handling the devices and use ESD-safe gloves



**This product can be damaged by electrostatic discharge (ESD). Handle with appropriate precautions.**

### Packaging

Our devices are placed in trays for shipment and SMD process. They are packed in sealed ESD-inner bag. We strongly advice to maintain our device in its original OEM sealed ESD inner-bag to guarantee storage condition before soldering them.

**Product identification markings**

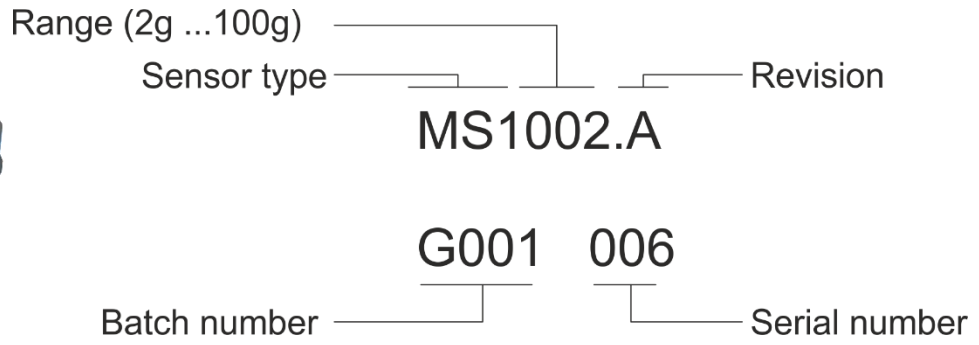
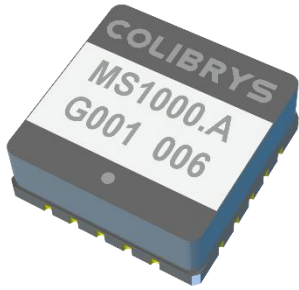

**Ordering Information**

Description	Product	Measurement range
Single analog axis MEMS accelerometer, 	MS1002.A	±2g
	MS1005.A	±5g
	MS1010.A	±10g
	MS1016.A	±16g
	MS1030.A	±30g
	MS1100.A	±100g

## Glossary of parameters of the Data Sheet

### Accelerometer model

$$\frac{OUT_P - OUT_N}{V_{DD}} * 3.3 = K_1(K_0 + A_s + K_2 \cdot A_s^2 + K_3 \cdot A_s^3 + K_p \cdot A_p + K_h * A_h + K_{sp} * A_s A_p + K_{sh} * A_s A_h + E)$$

A<sub>s</sub>, A<sub>p</sub>, A<sub>h</sub> are the accelerations for each axes of the sensor with:

Input Axis (IA): Sensitive axis

Pendulous Axis (PA): Aligned with the proof mass beam and perpendicular to the input axis

Hinge Axis (HA): Perpendicular to the input and pendulous axes. Direction of the dot.

K<sub>1</sub> is accelerometer scale factor [V/g]

K<sub>0</sub> is bias [g]

K<sub>2</sub> is second order non-linearity [g/g<sup>2</sup>]

K<sub>3</sub> is third order non-linearity [g/g<sup>3</sup>]

K<sub>p</sub> is pendulous cross-axis [rad]

K<sub>h</sub> is output cross-axis [rad]

K<sub>sp</sub>, K<sub>io</sub> are cross-coupling coefficients [rad/g]

E is the residual noise [g]

### g [m/s<sup>2</sup>]

Unit of acceleration, equal to standard value of the earth gravity (Accelerometer specifications and data supplied by Safran Colibrys use 9.80665 m/s<sup>2</sup>).

### Bias [mg]

The accelerometer output at zero g.

### Bias temperature coefficient [mg/°C]

Variation of the bias under variable external temperature conditions (slope of the best fit straight line through the curve of bias vs. temperature).

### Scale factor [mV/g]

The ratio of the change in output (in volts) to a unit change of the input (in units of acceleration); thus given in mV/g.

### Scale factor temperature coefficient [ppm/°C]

Maximum deviation of the scale factor under variable external temperature conditions.

### Temperature sensitivity

Sensitivity of a given performance characteristic (typically scale factor, bias, or axis misalignment) to operating temperature, specified generally at 20°C. Expressed as the change of the characteristic per degree of temperature change; a signed quantity, typically in ppm/°C for scale factor and mg/°C for bias. This figure is useful for predicting maximum scale factor error with temperature, as a variable when modelling is not accomplished.

### Non-linearity, IEEE [% FS]

Absolute maximum error versus full-scale acceleration

$$NL_{max} \equiv \left| \frac{V - K_1(K_0 + A_s)}{K_1 A_{FS}} \right|_{max} = \left| \frac{K_2 A_s^2 + K_3 A_s^3 + \dots}{A_{FS}} \right|_{max}$$

### Frequency response [Hz]

Frequency range from DC to the specified value where the variation in the frequency response amplitude is less than ±3 dB

### Noise [µg/√Hz]

Undesired perturbations in the accelerometer output signal, which are generally uncorrelated with desired or anticipated input accelerations.

**Long-term repeatability (Bias [mg] & Scale factor [ppm])**

Bias and scale factor residue over temperature [-40°C ; 85°C] after applying following environmental conditions:

- 100 x TurnOn / TurnOn
- short-term stability
- Low temperature storage (72h / -55°C)
- High temperature storage (10days / +85°C)
- 100 x temperature cycling [-40°C ; +125°C]
- High Temperature Operating Life (10 days / +85°C / powered)
- vibration (20grms / 10-2'000Hz)
- shock (5 x 500g / 0.5ms / 6 directions)

**TurnOn – TurnOn**

The accelerometer TurnOn TurnOn bias error is defined as the maximum bias error, when the accelerometer is turned on under defined operational conditions (3.3V supply voltage and ambient temperature).

**Vibration Rectification Error (VRE) [ $\mu\text{g}/\text{g}^2$ ]**

Steady-state error in the output while vibratory disturbances are acting on an accelerometer

## Quality

Safran Colibrys is ISO 9001:2015, ISO 14001:2015 and ISO 45001:2018 certified

Safran Colibrys complies with the European Community Regulation on chemicals and their safe use (EC 1907/2006) REACH

MS1000 products comply with the EU-RoHS directive 2011/65/EC (Restrictions on hazardous substances) regulations

Recycling : please use appropriate recycling process for electrical and electronic components (DEEE)

MS1000 products are compliant with the Swiss LSPro : 930.11 dedicated to the security of products

Note:

- *MS1000 accelerometers are available for sales to professional only*
- *Les accéléromètres MS1000 ne sont disponibles à la vente que pour des clients professionnels*
- *Die Produkte der Serie MS1000 sind nur im Vertrieb für kommerzielle Kunden verfügbar*
- *Gli accelerometri MS1000 sono disponibili alla vendita soltanto per clienti professionisti*

Safran Colibrys complies with due diligence requirements of the Conflict Minerals Regulation



## Disclaimer

Safran Colibrys reserves the right to make changes to products without any further notice.

Performance may vary from the specifications provided in Safran Colibrys' datasheet due to different applications and integration. Operating performance, including long-term repeatability, must be validated for each customer application by customer's technical experts. The long-term repeatability specification expressed in the datasheet is valid only in the defined environmental conditions (cf Long-term repeatability glossary), and the performance at system level remains the customer's responsibility.

The degolding process applied to the products is excluded from Safran Colibrys recommendations. And if applied, cancels any products warranty and liability.

USE OF THE PRODUCT IN ENVIRONMENTS EXCEEDING THE ENVIRONMENTAL SPECIFICATIONS SET FORTH IN THE DATASHEET WILL VOID ANY WARRANTY. SAFRAN COLIBRYS HEREBY EXPRESSLY DISCLAIMS ALL LIABILITY RELATED TO USE OF THE PRODUCT IN ENVIRONMENTS EXCEEDING THE ENVIRONMENTAL SPECIFICATIONS SET FORTH IN THE DATASHEET.